

# QUICK START GUIDE



---

**IMMERSIVE SURROUND SOUND PROCESSORS**

---

**SDR-35/SDP-55**

# QUICK START GUIDE



---

## IMMERSIVE SURROUND SOUND PROCESSORS

---

### SDR-35/SDP-55

Please be sure to check [www.jblsynthesis.com](http://www.jblsynthesis.com) for the latest version of this guide, Firmware updates, and other support material.

# Safety Guidelines

## Important Safety Instructions

1. Read these instructions.
2. Keep these instructions.
3. Heed all warnings.
4. Follow all instructions.
5. Do not use this apparatus near water.
6. Clean only with dry cloth.
7. Do not block any ventilation openings. Install in accordance with the manufacturer's instructions.
8. Do not install near any heat sources such as radiators, heat registers, stoves, or other apparatus (including amplifiers) that produce heat.
9. Do not defeat the safety purpose of the polarized or grounding-type plug.

A polarized plug has two blades with one wider than the other. A grounding type plug has two blades and a third grounding prong. The wide blade or the third prong are provided for your safety. If the provided plug does not fit into your outlet, consult an electrician for replacement of the obsolete outlet.

10. Protect the power cord from being walked on or pinched particularly at plugs, convenience receptacles, and the point where they exit from the apparatus.
11. Only use attachments/accessories specified by the manufacturer.
12. Use only with the cart, stand, tripod, bracket, or table specified by the manufacturer, or sold with the apparatus.

When a cart is used, use caution when moving the cart/apparatus combination to avoid injury from tip-over.



13. Unplug this apparatus during lightning storms or when unused for long periods of time.

14. Refer all servicing to qualified service personnel.

Service is required when the apparatus has been damaged in any way, such as power-supply cord or plug is damaged, liquid has been spilled or objects have fallen into the apparatus, the apparatus has been exposed to rain or moisture, does not operate normally, or has been dropped.

15. Object or liquid entry

WARNING – Take care that objects do not fall and liquids are not spilled into the enclosure through any openings. The equipment shall not be exposed to dripping or splashing. Liquid-filled objects such as vases should not be placed on the equipment.

16. Climate

The equipment has been designed for use in moderate climates and in domestic situations.

17. Cleaning

Unplug the unit from the mains supply before cleaning.

The case should normally only require a wipe with a soft, lint-free cloth. Do not use chemical solvents for cleaning.

We do not advise the use of furniture cleaning sprays or polishes as they can cause permanent white marks.

18. Power sources

Only connect the equipment to a power supply of the type described in the operating instructions or as marked on the equipment.

The primary method of isolating the equipment from the mains supply is to remove the mains plug. The equipment must be installed in a manner that makes disconnection possible.

19. Abnormal smell

If an abnormal smell or smoke is detected from the equipment, turn the power off immediately and unplug the equipment from the wall outlet. Contact your dealer and do not reconnect the equipment.

20. Damage requiring service

The equipment should be serviced by qualified service personnel when:

- A. The power-supply cord or the plug has been damaged, or

- B. Objects have fallen, or liquid has spilled into the equipment, or

- C. The equipment has been exposed to rain, or

- D. The equipment does not appear to operate normally or exhibits a marked change in performance, or

- E. The equipment has been dropped or the enclosure damaged.

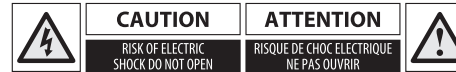

**CAUTION:** To reduce the risk of electric shock, do not remove cover (or back). No user serviceable parts inside. Refer servicing to qualified service personnel.

**WARNING:** To reduce the risk of fire or electric shock, do not expose this apparatus to rain or moisture.



The lightning flash with an arrowhead symbol within an equilateral triangle, is intended to alert the user to the presence of uninsulated 'dangerous voltage' within the product's enclosure that may be of sufficient magnitude to constitute a risk of electric shock to persons.



The exclamation point within an equilateral triangle is intended to alert the user to the presence of important operating and maintenance (servicing) instructions in the literature accompanying the product.

**CAUTION:** In Canada and the USA, to prevent electric shock, match the wide blade of the plug to the wide slot in the socket and insert the plug fully into the socket.

## Class II product

This equipment is a Class II or double insulated electrical appliance. It has been designed in such a way that it does not require a safety connection to electrical earth ("ground" in the U.S.)

## Warning

Mains plug/appliance coupler is used to disconnect device and it shall remain readily operable.

## Safety Compliance

This equipment has been designed to meet the IEC/EN 60065 international electrical safety standard.

This device complies with Part 15 of the FCC Rules. Operation is subject to the following two conditions:

1. This device may not cause harmful interference, and
2. This device must accept any interference received, including interference that may cause undesired operation.

The building installation shall be regarded as providing protection in accordance with the rating of the wall socket outlet.

## Caution on installation

For proper heat dispersal, do not install this unit in a confined space, such as a bookcase or similar enclosure.

- More than 0.3m (12in) is recommended.
- Do not place any other equipment on this unit.

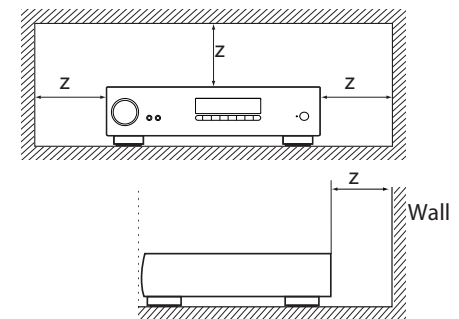

## FCC Information (for US customers)

### PRODUCT

This product complies with Part 15 of the FCC Rules. Operation is subject to the following two conditions:

1. This device may not cause harmful interference, and
2. This device must accept any interference received, including interference that may cause undesired operation.

### IMPORTANT NOTICE: DO NOT MODIFY THIS PRODUCT

This product, when installed as indicated in the instructions contained in this manual, meets FCC requirements. Modification not expressly approved by JBL SYNTHESIS may void your authority, granted by the FCC, to use the product.

### NOTE

This product has been tested and found to comply with the limits for a Class B digital device, pursuant to Part 15 of the FCC Rules. These limits are designed to provide reasonable protection against harmful interference in a residential installation.

This product generates, uses and can radiate radio frequency energy and, if not installed and used in accordance with the instructions, may cause harmful interference to radio communications. However, there is no guarantee that interference will not occur in a particular installation. If this product does cause harmful interference to radio or television reception, which can be determined by turning the product OFF and ON, the user is encouraged to try to correct the interference by one or more of the following measures:

- Reorient or relocate the receiving antenna.
- Increase the separation between the equipment and receiver.
- Connect the product into an outlet on a circuit different from that to which the receiver is connected.
- Consult the local retailer authorized to distribute this type of product or an experienced radio/TV technician for help

## Safety Information (for European customers)

- Avoid high temperatures. Allow for sufficient heat dispersion when installed in a rack.
- Handle the power cord carefully. Hold the plug when unplugging the cord.
- Keep the unit free from moisture, water, and dust.
- Unplug the power cord when not using the unit for long periods of time.
- Do not obstruct the ventilation holes.
- Do not let foreign objects into the unit.
- Do not let insecticides, benzene, and thinner come in contact with the unit.
- Never disassemble or modify the unit in any way.
- Ventilation should not be impeded by covering the ventilation openings with items, such as newspapers, tablecloths or curtains.
- Naked flame sources such as lighted candles should not be placed on the unit.
- Observe and follow local regulations regarding battery disposal.
- Do not expose the unit to dripping or splashing fluids.
- Do not place objects filled with liquids, such as vases, on the unit.
- Do not handle the mains cord with wet hands.
- When the switch is in the OFF position, the equipment is not completely switched off from MAINS.
- The equipment shall be installed near the power supply so that the power supply is easily accessible.

## A note about recycling

This product's packaging materials are recyclable and can be reused. Please dispose of any materials in accordance with the local recycling regulations.

When discarding the unit, comply with local rules or regulations.

Batteries should never be thrown away or incinerated but disposed of in accordance with the local regulations concerning battery disposal.

This product and the supplied accessories, excluding the batteries, constitute the applicable product according to the WEEE directive

## Correct disposal of this product

These markings indicate that this product should not be disposed with other household waste throughout the EU.



To prevent possible harm to the environment or human health from uncontrolled waste disposal and to conserve material resources, this product should be recycled responsibly.

To dispose of your product, please use your local return and collection systems or contact the retailer where the product was purchased.



## Welcome

### Thank you and congratulations...

...for purchasing your JBL Synthesis Immersive Surround Sound Processor.

The JBL Synthesis SDR-35 Class G Immersive Surround Sound AV Receiver and SDP-55 Surround Sound Processor are designed to ensure exceptional performance without compromise. With best-in-class audio and video signal integrity, 16 channels of native processing, Dolby ATMOS®, DTS:X®, Auro 3D®, IMAX® Enhanced, Dirac Live®, Logic16™, Network Streaming, Dante® and Class G amplification; the JBL Synthesis® SDR-35 and SDP-55 deliver a powerful, sensory-rich experience with unrivaled flexibility.

#### Immerse Yourself

Best in class audio and video signal integrity and processing, as well as uncompromising Class G amplification, ensure exceptional transparency even with the most demanding program material. An audiophile-grade 24Bit / 192kHz ESS Sabre Pro DAC, combined with Dirac Live room equalization and the exceptional dynamics and low distortion of Class G amplification ensure pristine sound for music and movies. The Harman proprietary Logic 16 up mixer allows content to envelop the listener with a rich and natural three dimensional sound, no matter the source format.

#### Your Content Your way

Many high-end AVR's exclude real world everyday conveniences for the end-user. The SDR-35 provides a variety of ways to experience content whether using an elaborate network media server over Ethernet or Wi-Fi or simply streaming directly from your tablet or phone via Bluetooth with aptX™ HD. You can source content from a smart TV with high-resolution audio via eARC, utilize Chromecast® built-in and Apple® AirPlay 2™. Use the MusicLife™ app to play your own music library from a computer or NAS drive, or play directly from a USB flash drive. There's even a DAB/FM antenna for OTA radio!

#### Superior Video

Advanced circuitry and decades of know-how ensure the 4K "Ultra HD" video signal is perfectly clear and rock solid. The video stages are designed to harness the latest technology and deliver the best quality formats including Dolby Vision™, HLG, HDR10, HDR10+, HDMI2.0b with HDCP2.2, and 3D video capabilities built-in.

#### IMAX Enhanced

JBL Synthesis® SDR-35 and SDP-55 are IMAX Enhanced-certified AV processors and feature DTS:X immersive audio decoding that is optimized to properly reproduce the full dynamic range of IMAX theatrical sound mixes available in IMAX Enhanced content. With meticulous adjustments modeled on the IMAX theatrical sound system, this proprietary IMAX audio mix is translated for home theater environments and exclusively delivered using a special variant of the DTS:X CODEC technology to deliver the IMAX signature sound experience in the home.

#### A More Dramatic TV Experience

Dolby Vision™ is superior HDR. Using the same underlying technology as the most advanced movie theatres, Dolby Vision enables an enhanced image through superior content and smarter TV display performance.

#### Audiophile Quality

The SDR-35 and SDP-55 leverage the 24bit /192 kHz ESS® Sabre 9028 Pro featuring 114dB dynamic range and -100 THD+N in and out, for A/D and D/A conversion. The analog circuitry on the input and output stages is optimized for unequalled dynamic range, ultra-low distortion, and unmatched audio clarity. Carefully designed anti-jitter circuitry and ultra-clean power supplies are incorporated to ensure all audio paths, including HDMI, are uncompromised.

#### Class G Amplification – The Best of Both Worlds

The SDR-35 AV Receiver features seven channels of Class G amplification. Class G offers greater efficiency and transparency, with less wasted heat energy than class A. Like a hybrid car engine, Class G implements multiple power supplies. The first power supply runs in pure Class A, which has no crossover distortion. If a dynamic signal is received that goes beyond the capability of this first power supply, the secondary supply is gradually incorporated up to full rated power output as required. This efficient design means additional power is only used when required. Modern high-speed silicon allows this switch to take place well beyond the audio bandwidth. Multiple output devices within the amplifier ensure your listening experience is powerful, dynamic and crystal clear.

#### Flexibility

With 15.1 decoding, 9.1.6 preamp outputs, plus seven channels of amplification, independent Zone 2 combined with RS232, Ethernet and app control, the SDR-35 and SDP-55 offer exceptional versatility. Four of the sixteen channels allow independent volume and delay settings for added configuration options. Independent volume control for the subwoofers allow fine-tuning, and front panel headphone and aux (3.5mm) jacks add convenience. The JBL Synthesis Control app enables complete control of the SDR-35 with an Android or iOS device. Flexible configuration, including Dante, IP, IR, and RS232 control and a Zone 2 with high-resolution audio, 4K video, IR, triggers, and power option, make the SDR-35 an outstanding choice for a broad range of applications.

For the latest version of this guide, Firmware updates, and other support material, and links, please be sure to check [www.jblsynthesis.com](http://www.jblsynthesis.com).

## JBL Synthesis Development Team

## Contents

Safety Guidelines	EN-2	Decoding Modes	EN-35
Welcome	EN-4	Tuner Operation	EN-37
Before You Begin...	EN-6	Troubleshooting	EN-38
Trademark Acknowledgments	EN-8	Specifications	EN-40
Rear Panel Connections and Controls	EN-9	Worldwide Guarantee	EN-42
Audio/Video Connections	EN-10		
Connection Guide	EN-12		
Radio & Wireless Audio Connectors	EN-13		
Other Connectors	EN-14		
Speakers	EN-15		
Connecting Speakers	EN-16		
Operation	EN-17		
Extended front panel menu	EN-18		
Updating firmware via USB	EN-18		
Front Panel Operation	EN-19		
Remote Control	EN-20		
Customising the Remote	EN-22	<b>Professional installation?</b>	
Essential Setup	EN-28	It may be that the Receiver has been installed and set up as part of your Hi-Fi installation by a qualified JBL Synthesis dealer. In this case, you may wish to skip the sections of this handbook dealing with installation and setting up, and move directly to the sections dealing with using the unit. Use the Contents list to guide you to these sections.	
Auto Speaker Setup	EN-29	<b>DIY setup?</b>	
Setup Menus	EN-30	The Receiver is a powerful and sophisticated piece of AV equipment. If you are setting the unit up yourself, it is recommended that you read this handbook thoroughly before beginning. For instance, correct speaker configuration and placement is a key to getting the most out of your Receiver and making sure that all the elements of your system work in harmony.	
Connecting to a Network	EN-34		

## Before You Begin...

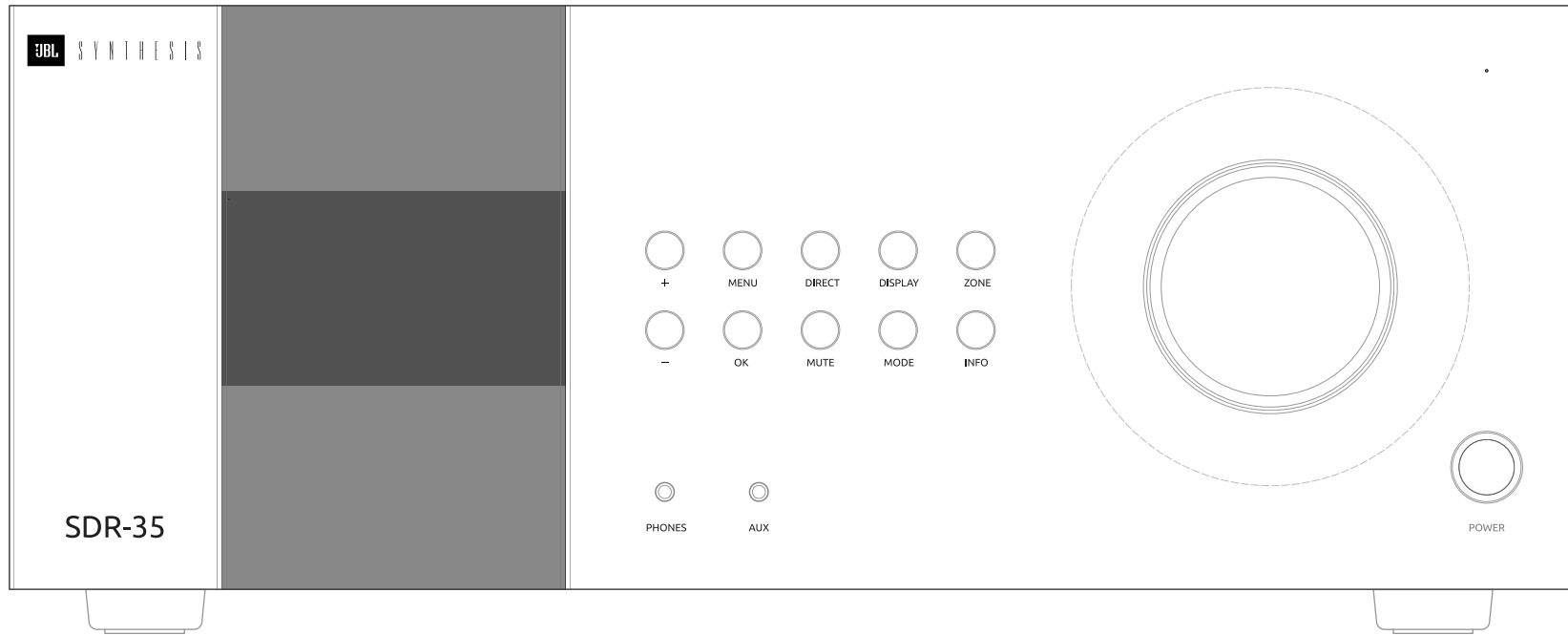

### JBL Synthesis Receiver

The JBL Synthesis receiver and processor are high-quality and high-performance private-cinema processors and amplifiers built to JBL Synthesis' quality design and manufacturing standards. They combine digital processing with high-resolution audio and video components to bring you an unrivalled home-entertainment experience.

The Receiver allows switching and control of seven analog and six digital audio sources in addition to internal FM and DAB+ radios – as well as networked audio sources – making any of the models an ideal hub for both home-cinema and two-channel stereo systems.

Since many of these source components are also capable of generating video signals, the Receiver includes broadcast-quality switching for HDMI (7 x HDMI2.0b, HDCP2.2) video/audio signals. Control of the Receiver is either by front panel control buttons, IR remote control, IP (Ethernet) control or RS232 port.

The remote control supplied with the Receiver is a multi-device 'universal' learning remote control which is simple to use, and once set up is able to control a complete system. It can be programmed using its vast internal code library to control CD and BD players, PVRs, TVs and other devices.

The installation of the Receiver in a listening room is an important process which requires care at every stage. For this reason, the installation information is very comprehensive and should be followed carefully to achieve an unrivalled level of performance.

The JBL Synthesis SDR-35 and SDP-55 are designed to ensure a powerful, sensory-rich experience with exceptional clarity and realism.

## Placing the unit

- Place the unit on a level, firm surface, avoiding direct sunlight and sources of heat or damp.
- Do not place the Receiver on top of a power amplifier or other source of heat.
- Do not place the amplifier in an enclosed space such as a bookcase or closed cabinet unless there is good provision for ventilation (see page EN-2). The Receiver will run warm during normal operation.
- Do not place any other component or item on top of the amplifier as this may obstruct airflow around the heat-sink, causing the amplifier to run hot. (The unit placed on top of the amplifier would become hot, too.)
- Make sure the remote-control receiver on the front panel display is unobstructed, otherwise this will impair the use of the remote-control. If line-of-sight is impractical, a remote-control repeater can be used with the rear panel connector (see page EN-34).
- Do not place your turntable on top of this unit. Turntables are very sensitive to the noise generated by mains power supplies which will be heard as a background 'hum' if the turntable is too close.

## Power

The amplifier is supplied with a molded AC plug already attached to the cord. Check that the plug supplied fits your outlet – should you require a new power cord, please contact your JBL Synthesis dealer.

If your AC voltage supply or power cord is different, please contact your JBL Synthesis dealer immediately.

The Receiver can be switched for operation between 220–240V (switch position 230V) and 110–120V (switch position 115V).

***NOTE: Ensure that the Receiver is switched off and the power cord removed before changing the position of the voltage range switch.***

Push the IEC plug end of the power cord into the socket on the back of the amplifier, making sure that it is pushed in firmly. Plug the other end of the cord into your AC outlet.

The Receiver can be turned on using the power switch on the front panel. While switched on, the front panel LED will glow white.

## Standby power

The Receiver can be switched into standby mode using the  button on the remote control. While in standby mode the front panel LED will glow red and (with default settings) power consumption is less than 0.5 Watts.

While in Standby mode, it may be possible to hear a slight residual hum coming from the mains transformer inside the amplifier. This is perfectly normal. However, if the unit is to be left unused for an extended period, we recommend that you disconnect it from the AC outlet to save power.

## Interconnect cables

We recommend the use of high-quality shielded cables that are designed for the particular application. Other cables will have different impedance characteristics that will degrade the performance of your system (for example, do not use cabling intended for video use to carry audio signals). All cables should be kept as short as is practically possible.

It is good practice when connecting your equipment to make sure that the AC power-supply cabling is kept as far away as possible from your audio cables. Failure to do so may result in unwanted noise in the audio signals.

For information on speaker cables, please refer to the 'Speakers' section, beginning on page EN-16.

## Radio interference

The Receiver is an audio device containing microprocessors and other digital electronics. Each model has been designed to very high standards of electromagnetic compatibility.









This is a Class A product. In a domestic environment this product may cause radio interference, in which case the user may be required to take adequate measures.





If the Receiver causes interference to radio or television reception (which can be determined by switching the Receiver off and on), the following measures should be taken:

- Re-orient the receiving antenna or route the antenna cable of the affected device as far as possible from the JBL Synthesis Receiver and its cabling.
- Relocate the affected device with respect to the JBL Synthesis Receiver.
- Connect the affected device and the Receiver to different mains outlets.

If the problem persists, please contact your JBL Synthesis dealer.

# Trademark Acknowledgments

	<b>Dolby Vision, Dolby Atmos, Dolby Audio</b>  Manufactured under license from Dolby Laboratories. Dolby, Dolby Vision, Dolby Atmos, Dolby Audio, and the double-D symbol are registered trademarks of Dolby Laboratories.
	<b>DTS:X®</b>  For DTS patents, see <a href="http://patents.dts.com">http://patents.dts.com</a> . Manufactured under license from DTS Licensing Limited. DTS, the Symbol, DTS in combination with the symbol, DTS:X and the DTS:X logo are registered trademarks or trademarks of DTS, Inc. in the United States and/or other countries. © DTS, Inc. All Rights Reserved.
	<b>DTS Virtual:X™</b>  For DTS patents, see <a href="http://patents.dts.com">http://patents.dts.com</a> . Manufactured under license from DTS Licensing Limited. DTS, the Symbol, DTS and the symbol together, Virtual:X and the DTS Virtual:X logo are registered trademarks and/or trademarks of DTS, Inc. in the United States and/or other countries. © DTS, Inc. All Rights Reserved.
	<b>IMAX® &amp; DTS®</b>  Manufactured under license from IMAX Corporation. IMAX® is a registered trademark of IMAX Corporation in the United States and/or other countries. For DTS patents, see <a href="http://patents.dts.com">http://patents.dts.com</a> . Manufactured under license from DTS Licensing Limited. DTS, the Symbol, DTS and the symbol together are registered trademarks or trademarks of DTS, Inc. in the United States and/or other countries. © DTS, Inc. All Rights Reserved.
	<b>Auro-3D®</b>  Auro-3D® is a registered trademark of Auro Technologies.
	<b>AAC/AAC Plus</b>  aacPlus is a trademark of Coding Technologies. See <a href="http://codtech.vhost.noris.net">http://codtech.vhost.noris.net</a> for more information.
	HDMI, the HDMI logo and High-Definition Multimedia Interface are trademarks or registered trademarks of HDMI Licensing LLC.
	The Bluetooth® word mark and logos are registered trademarks owned by the Bluetooth SIG, Inc. and any use of such marks by HARMAN International Industries, Incorporated is under license. Other trademarks and trade names are those of their respective owners.

	Qualcomm is a trademark of Qualcomm Incorporated, registered in the United States and other countries. aptX is a trademark of Qualcomm Technologies International, Ltd., registered in the United States and other countries.
	Apple, AirPlay and the AirPlay logo, iPod, iPhone and iPad are trademarks of Apple Inc., registered in the U.S. and other countries. App Store is a service mark of Apple Inc.  AirPlay 2 works with iPhone, iPad, and iPod touch with iOS 11.4 or later, Mac with OS X Mountain Lion or later, and PC with iTunes 10.2.2 or later.
	The Wi-Fi CERTIFIED Logo is certification marks of the Wi-Fi Alliance.
	Google, Google Play, Chromecast, and other related marks are trademarks of Google LLC. The Google Assistant requires an internet connection and is not available in certain countries and languages. Availability and react of certain features and services are device, service, and network-dependent and may not be available in all areas. Controlling certain devices in your home requires compatible smart devices. Subscriptions for services and applications may be required and additional terms, conditions and/or charges may apply.
vTuner	This product is protected by certain intellectual property rights of NEMS and BridgeCo. Use or distribution of such technology outside of this product is prohibited without a license from NEMS and BridgeCo or an authorized subsidiary.
MP3	MPEG Layer-3 audio decoding technology licensed from Fraunhofer IIS and Thomson multimedia.

<b>FLAC</b>	FLAC Decoder Copyright © 2000, 2001, 2002, 2003, 2004, 2005, 2006, 2007, 2008 Josh Coalson  Redistribution and use in source and binary forms, with or without modification, are permitted provided that the following conditions are met:  - Redistributions of source code must retain the above copyright notice, this list of conditions and the following disclaimer.  - Redistributions in binary form must reproduce the above copyright notice, this list of conditions and the following disclaimer in the documentation and/or other materials provided with the distribution.  - Neither the name of the Xiph.org Foundation nor the names of its contributors may be used to endorse or promote products derived from this software without specific prior written permission.  THIS SOFTWARE IS PROVIDED BY THE COPYRIGHT HOLDERS AND CONTRIBUTORS 'AS IS' AND ANY EXPRESS OR IMPLIED WARRANTIES, INCLUDING, BUT NOT LIMITED TO, THE IMPLIED WARRANTIES OF MERCHANTABILITY AND FITNESS FOR A PARTICULAR PURPOSE ARE DISCLAIMED. IN NO EVENT SHALL THE FOUNDATION OR CONTRIBUTORS BE LIABLE FOR ANY DIRECT, INDIRECT, INCIDENTAL, SPECIAL, EXEMPLARY, OR CONSEQUENTIAL DAMAGES (INCLUDING, BUT NOT LIMITED TO, PROCUREMENT OF SUBSTITUTE GOODS OR SERVICES; LOSS OF USE, DATA, OR PROFITS; OR BUSINESS INTERRUPTION) HOWEVER CAUSED AND ON ANY THEORY OF LIABILITY, WHETHER IN CONTRACT, STRICT LIABILITY, OR TORT (INCLUDING NEGLIGENCE OR OTHERWISE) ARISING IN ANY WAY OUT OF THE USE OF THIS SOFTWARE, EVEN IF ADVISED OF THE POSSIBILITY OF SUCH DAMAGE.
-------------	---

	MQA (Master Quality Authenticated)  MQA is an award-winning British technology that delivers the sound of the original master recording. The master MQA file is fully authenticated and is small enough to stream or download.  Visit <a href="http://mqa.co.uk">mqa.co.uk</a> for more information.  JBL Synthesis AVRs include MQA technology, which enables you to play back MQA audio files and streams, delivering the sound of the original master recording.  'MQA' or 'MQA Studio' indicates that the product is decoding and playing an MQA stream or file, and denotes provenance to ensure that the sound is identical to that of the source material. 'MQA Studio' indicates it is playing an MQA Studio file, which has either been approved in the studio by the artist/producer or has been verified by the copyright owner.  MQA and the Sound Wave Device are registered trade marks of MQA Limited. © 2016
---	--

# Rear Panel Connections and Controls

**!** Please read the 'Placing the unit', 'Power' and 'Interconnect cables' sections on page EN-7 before connecting up your Receiver!

**NETWORK CONNECTORS**  
For information, see page EN-13, EN-14.

**DANTE PORTS**  
For information, see page EN-10.

**HDMI CONNECTORS**  
For information, see page EN-10.

**USB PORT**  
See page EN-14.

**PREAMPLIFIER INPUTS**  
See page EN-11.

**FM/DAB**  
FM aerial socket, or DAB aerial socket.

**DIGITAL CONNECTORS**  
Coaxial and optical digital audio connectors, see page EN-11.

**NETWORK/BLUETOOTH CONNECTORS**  
For information, see page EN-13,

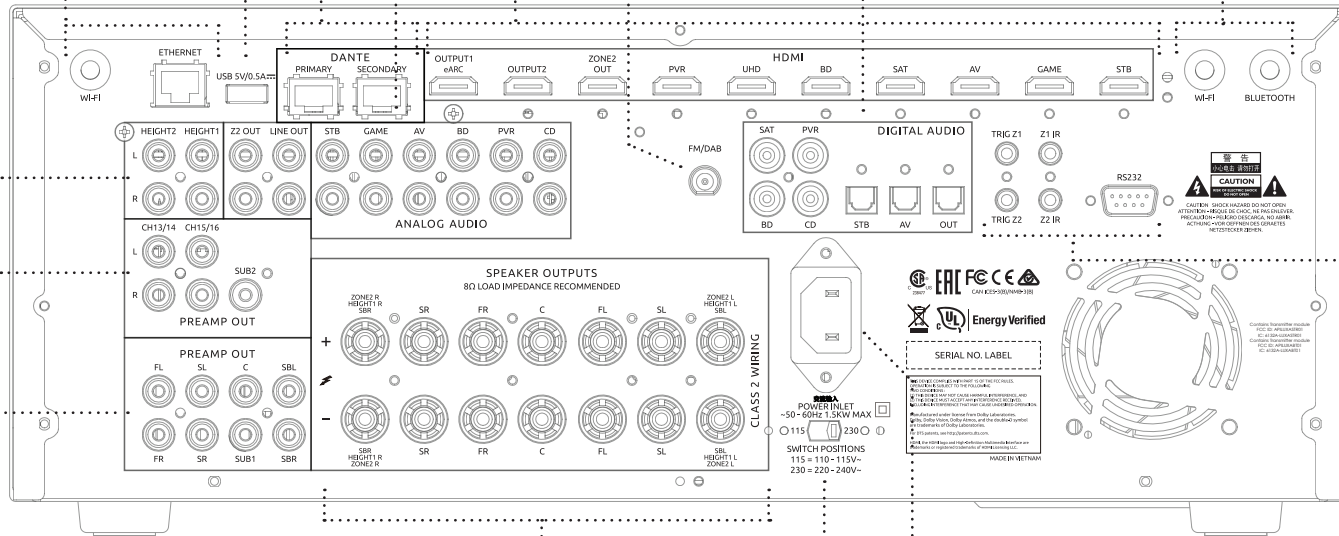

**SERIAL AND IR CONTROL**  
Serial control, trigger and IR connectors, see page EN-14.

**PREAMPLIFIER OUTPUTS**  
See page EN-11.

**SPEAKER CONNECTORS**  
For information, see page EN-16.

**POWER**  
Connect the correct mains cable here

**VOLTAGE SELECT**  
Ensure the voltage selected matches your local power supply.

# Audio/Video Connections

Before connecting your Receiver to your source components and speakers, please read through the next few pages which will explain all the input and output connectivity that is available. The 'Speakers' section explains how to connect up your speakers to avoid damage to the amplifier and how to arrange your speakers for best performance.

## General

The inputs are named to make it easier to reference connected devices (e.g. **BD** or **UHD**). They all have the same input circuit, so there is no reason why you should not connect a different device to any of the inputs. For example, if you had two BD players and the AV input was not being used, then the second BD player could be connected to the AV input.

When connecting a video source, its audio must be connected to the corresponding sockets. For example, if you had a satellite decoder plugged into a **SAT** video input, the audio must be connected to the **SAT** audio inputs!

## Making connections

- Take care to place cables as far from any power supply cables as is practicable, to reduce hum and other noise problems.

**NOTE: For each input, you must set the 'Video Source' and 'Audio Source' settings according to the connection type. (see "Input Config." on page EN-31)**

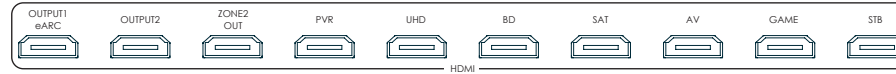

## HDMI connectors

### PVR, UHD, BD, SAT, AV, GAME, STB

Connect the HDMI video outputs of your source equipment to these corresponding HDMI inputs.

### OUTPUT

Connect this output to the HDMI video input of your display device. Output 1 is compatible with HDMI Enhanced Audio Return Channel (eARC). If you have a supported TV/Smart TV then sound from the television's internal tuner or streaming platform (e.g. Roku, Netflix, Hulu) will be available using the Receiver's 'Display' input.

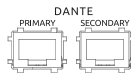

## Dante ports

Dante is a licensed technology from Audinate®. It uses standard Internet Protocols over a 100Mb or Gigabit network and is capable of transporting professional-quality, low-latency audio. Dante runs on standard computer networking hardware and does not require dedicated network infrastructure; Ethernet switches transmit Dante digital media streams alongside ordinary data traffic. The physical Dante connections must be made using Category 5e or Category 6 cables 100m/328ft between devices when using a Gigabit network. The two Dante (RJ-45) ports on the back of the SDR-35 and SDP-55 can be used to transmit high-resolution digital audio to other

### Dante-enabled devices connected to the same network

Dante is configured and controlled using the Dante Controller software which is a free download for Windows or mac OS which can be downloaded at [www.audinate.com/products/software/dante-controller](http://www.audinate.com/products/software/dante-controller)

Dante works independently of the unit control (via the Ethernet jack on the SDR-55 and SDP-55).

Be sure to use the Dante jacks only for Dante networking applications. For more information on Dante, please visit [www.jblsynthesis.com](http://www.jblsynthesis.com)

## Digital audio connectors

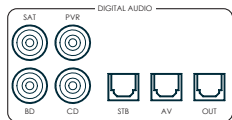

### SAT, PVR, BD, CD, STB, AV

Connect these inputs to the digital outputs of your available source equipment.

## Zone 2 connectors

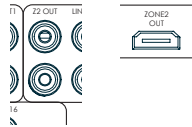

The Z2 out HDMI connector can be used to connect the output of the Receiver to a system located in a second room.

## Analog preamplifier outputs

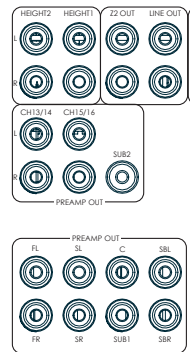

All preamplifier analog outputs are buffered, have a low output impedance, are at line level and follow the Zone 1 volume control setting. They are able to drive long cables or several inputs in parallel if required.

For more information on connecting speakers or additional power amplifiers, see pages EN-9 and EN-16.

The SDP-55 has XLR outputs in addition to the RCA (or unbalanced) pre-outs for connection to an external amplifier.

## Analog audio inputs

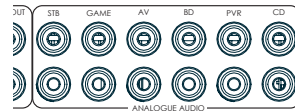

### STB, GAME, AV, BD, PVR, CD

Connect the left and right inputs to the left and right outputs of your source equipment.

## Front panel AUX input



The front panel **AUX** input can be used as an analog input, using a stereo 3.5mm lead.

## Front panel headphone jack

This socket accepts headphones with an impedance rating between 32Ω and 600Ω, fitted with a 3.5mm stereo jack plug. The headphone socket is always active, except when Receiver is muted.

When the headphone plug is inserted, the speaker outputs and analog preamplifier outputs are automatically muted.



## Connection Guide

### Blu-ray Disc (BD)/DVD player

The diagram shows how to make audio and video connections from a typical BD/DVD player.

Whether HDMI, digital or analog connections are used, connecting using the input/inputs labelled **BD** on the Receiver will aid in operation.

### Satellite receiver

A satellite receiver is connected with the same order of preference according to the outputs provided by the satellite receiver.

### CD player

Connect the digital output to the digital **CD** input of the Receiver and analog output to the analog **CD** input of the Receiver, using a high quality interconnect cable.

**NOTE: For each input, you must set the 'Audio Source' setting according to the connection type. (see "Input Config." on page EN-31)**

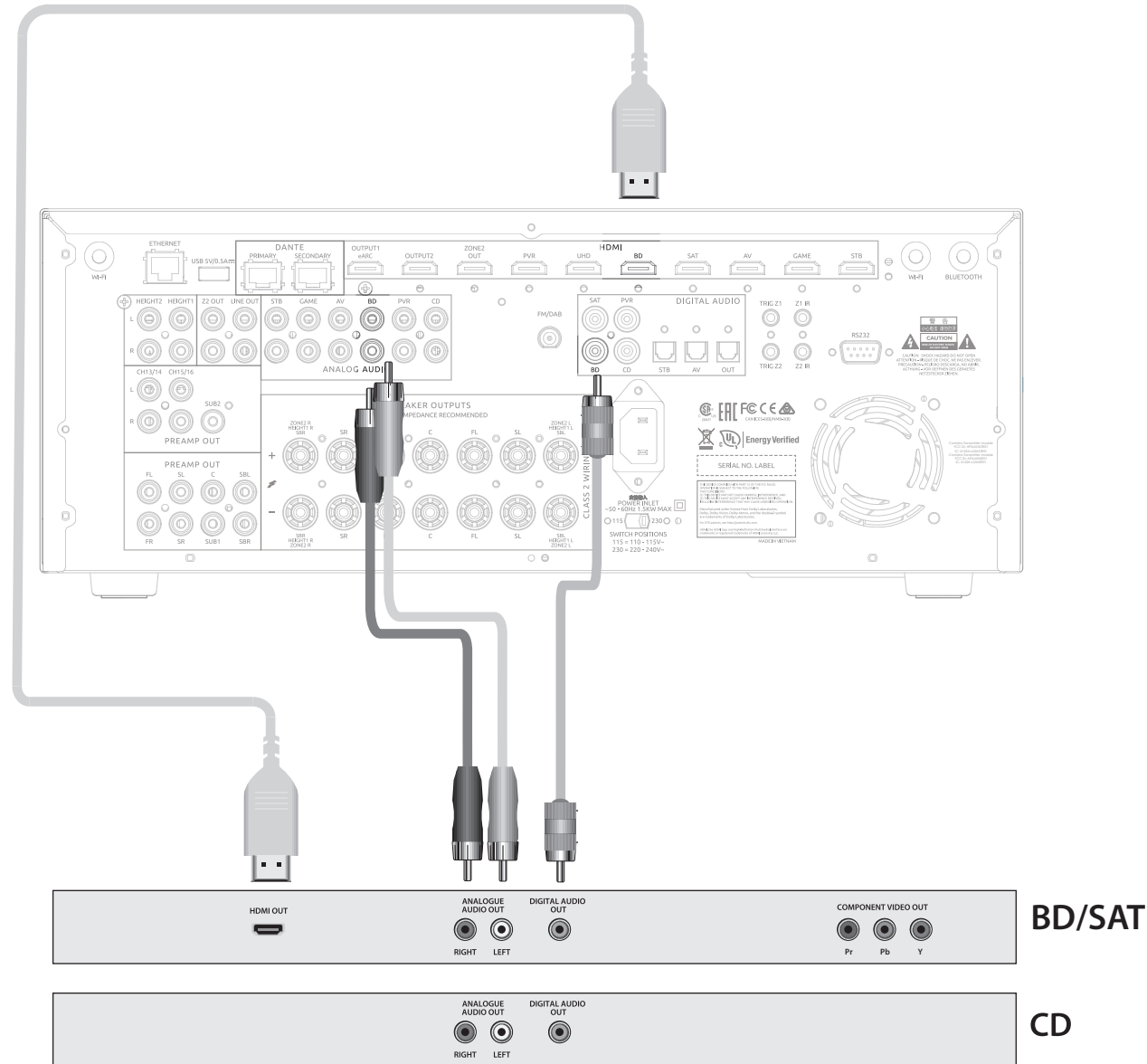

## Radio & Wireless Audio Connectors

### DAB/FM connector

The Receiver is fitted with an FM and a DAB/DAB+ receiver module. The type of aerial you need depends on your listening preferences and the local conditions.

Your Receiver is capable of superb radio reception, but only if it is receiving a good quality transmission signal.

Try the antennas supplied with your unit. If you are in a medium to strong signal area, these should be adequate for good reception. In areas with poor signal strength, you may require a roof or loft mounted aerial.

Contact your local JBL Synthesis dealer or aerial installation experts for advice about local reception conditions.

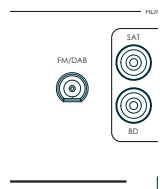

In strong signal areas, the DAB/FM 'T' wire antenna supplied can be used with reasonable results. Mount the antenna as high up as possible on a wall.

In the UK the 'T'-elements need to be positioned vertically for DAB reception since broadcasts are vertically polarised. In other localities, check with your JBL Synthesis dealer or try both horizontal and vertical positions for best reception.

Try each usable wall of the room to see which gives best reception and use tacks or adhesive tape to secure the aerial in a 'T' shape, but note that no tacks should come into contact with the internal wire of the aerial.

When installed and receiving DAB/FM, check the signal strength by pressing the front panel or remote control's **INFO** button until the signal quality indicator is displayed.

In weak signal areas, a high-gain, externally-mounted or roof-mounted antenna is desirable in order to receive the highest number of services.

In Band III transmission areas (such as the UK), use a multi-element Yagi aerial with the elements mounted vertically, as the transmissions are vertically polarised. If you are close to more than one transmitter, use an omnidirectional or folded dipole aerial.

If the DAB services in your area are transmitted on L-band, then ask your dealer for advice for the best aerial to use.

### Wi-Fi/Bluetooth

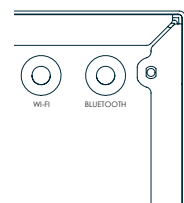

If using the Wi-Fi or Bluetooth features of the Receiver, please attach the single antenna for the Bluetooth and the two antennas for the Wi-Fi.

## Other Connectors

### Serial connector

#### RS232 serial connector

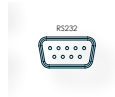

The connector is used with control devices having an RS232 serial port (for example, Crestron and AMX touch-screen controllers).

### Network connector

Networking is a large subject and only the briefest guidelines are presented in this handbook. Please contact your JBL Synthesis dealer or specialist installer for more information about introducing the Receiver into your computer network.

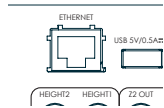

### Ethernet

If an Ethernet cable is connected, the Receiver will automatically attempt to connect to your network.

You should use a CAT5 or above cable plugged into the RJ45 socket labelled **ETHERNET** on the rear panel.

If your network uses static IP addressing rather than DHCP, you will need to provide an IP address, gateway and DNS address; see page EN-34 for information on setting up the network.

### USB connector

The Receiver can be updated via the USB port on the rear of the unit, if no network connection is available for an "Over the air" update.

### Trigger connectors

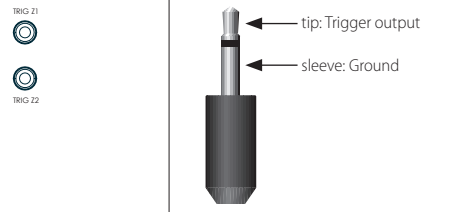

The trigger connectors (**TRIG Z1** and **TRIG Z2**) provide an electrical signal whenever the Receiver is switched on and the relevant zone enabled.

The trigger signal can be used to switch on and off compatible pieces of home entertainment equipment, for example, you could set up a trigger to turn on your television and BD player whenever the Receiver was switched on.

There are two trigger output sockets on the Receiver, each capable of outputting a 12V, 70mA switching signal. The socket is designed for mono 3.5mm jacks: tip is the trigger output, sleeve is ground.

#### **TRIG Z1**

Use for remotely turning on and off power amps or source equipment for Zone 1. On = 12V, Off = 0V.

#### **TRIG Z2 (Not AVR10)**

Use for remotely turning on and off power amps or source equipment for Zone 2. On = 12V, Off = 0V.

### Infrared (IR) connectors

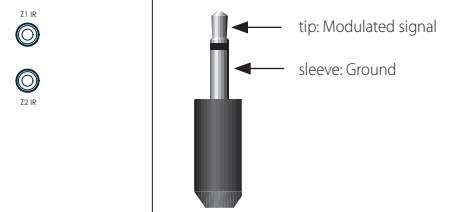

The infrared inputs (**Z1 IR** and **Z2 IR**) allow the connection of external IR receivers, either when the Receiver front panel IR receiver is fully or partially obstructed or to allow the use of a remote control in Zone 2.

There are two IR inputs on the Receiver, each designed for stereo or mono 3.5mm jacks. Tip is the modulated signal, sleeve is ground.

#### **Z1 IR**

This input is intended for use with a local IR receiver when the front panel of the Receiver is blocked.

#### **Z2 IR (Not AVR10)**

This input is intended for use with an IR receiver in Zone 2 to allow remote control of Receiver from a second room.

A supplier of infra-red receivers and emitter accessories and systems is Xantech. See [www.xantech.com](http://www.xantech.com) for more information, or ask your JBL Synthesis dealer.

**NOTE: The IR inputs on the Receiver are designed for modulated signals. If the external IR receiver demodulates the IR signal, it will not work. Also the unit does not provide power for external receivers on the IR jack, therefore an external power source will be required.**

**NOTE: Sockets referring to 'Z2' relate to connections used in multi-room installation. For more information on these connectors, see page EN-11.**

## Speakers

The SDR-35 and SDP-55 allow you to connect up to sixteen speakers. The SDP-55 needs additional power amplifiers to utilize all 16 channels. The SDR-35 and SDP-55 has 7 channels of amplification. 5 channels of amplification correspond to speakers installed in the front left, center, front right, surround left, surround right. The remaining 2 channels of amplification can be assigned as:

- bi-amp the front left and right
- surround back left and surround back right
- height 1 left and right
- Zone 2 left and right

Height front left, height front right, height back left, height back right and five more additional speakers can be attached using an additional power amplifier, see page EN-16 for more information.

With the addition of correctly installed and configured height channels, Dolby Atmos for the home, DTS:X or Auro 3D brings the ultimate cinema sound experience to your home theatre to create powerful, moving audio that flows around you.

**The configuration and placement of your speakers is very important.** All speakers, with the exception of the subwoofer(s), should be arranged around your normal viewing/listening position. The SDR-35 and SDP-55 decode Dolby, DTS, and Auro3D surround formats. Each has unique requirements for speaker placement. In addition the processors are equipped with Dirac Bass Management for multiple sub-woofers. The speaker placement and system calibration should be performed by a certified JBL Synthesis Dealer for optimum performance in all formats.

It is imperative that low frequencies are evenly distributed across all seating positions. This is best achieved using multiple sub-woofers. Best results are usually achieved by placing sub-woofers in all four corners of the room, performing precise measurements and making the proper adjustments to time, frequency and amplitude domains to minimize seat to seat variation and maximize performance for the unique physical characteristics of a particular room.

Certified JBL Synthesis Calibrators are equipped with the experience and tools to implement the best possible calibration for each room.

For more information on room calibration and sound field management visit [www.jblsynthesis.com](http://www.jblsynthesis.com)

## Connecting Speakers

To connect each of the speakers, unscrew the corresponding terminals on the back of the Receiver, insert the speaker wires through the hole in each post and screw the terminals down. Make sure that the red (positive/+) terminal of the speaker is connected to the red (positive/+) terminal on the back panel, and the black (negative/-) terminal of the speaker is connected to the black (negative/-) terminal on the back panel.

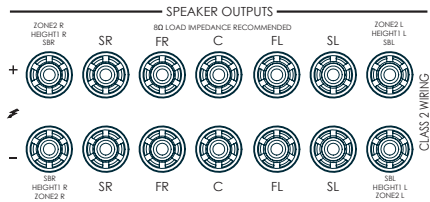

It is important that no stray strands of wire from these connections are allowed to touch another cable or the back panel. Failure to ensure this can cause a short circuit and damage your Receiver.

**Ensure the unit is switched off while connecting speakers. Do not over-tighten the loudspeaker terminals, or use a wrench, pliers, etc., as this could damage the terminals and this would not be covered under the product's warranty.**

### Speaker cables

The speakers should be connected to the amplifier using high-quality, copper cables. A heavy gauge (thick copper) and as short as practical is ideal. The gauge should be heavier (a lower number) for longer runs. Using speaker cables that are too long and/or thin gauge can significantly degrade the sound quality.

Connections to the speaker terminals should always be finger tight, whether using bare wires or spade connectors.

## Bi-amping the Front Left & Front Right speakers

Bi-amping is the use of two amplifier channels per speaker. Bi-amping can provide better sound quality than conventional single wiring. If you do not have Surround Back speakers (i.e. you have a 5.1 surround system, not a 7.1 system) then you can use the spare Surround Back speaker outputs to bi-amplify the front left and right speakers, if your speakers support bi-amping. The spare channels can alternatively be used to power stereo speakers in another room (Zone 2).

Speakers that support bi-amping have two sets of +/- terminals per speaker, usually linked together by metal strips. These metal strips **MUST** be removed when bi-amping; failure to remove them will result in damage to the amplifier that is not covered under warranty.

To bi-amp the front left and right speakers, remove the metal strips from the speaker terminals. Connect the woofer or LF terminals to the FL and FR terminals on the Receiver. Finally, navigate to the Setup Menu 'Spkr Types' and set the 'Use Channels 6+7' menu option to 'BiAmp L+R'; see page EN-32.

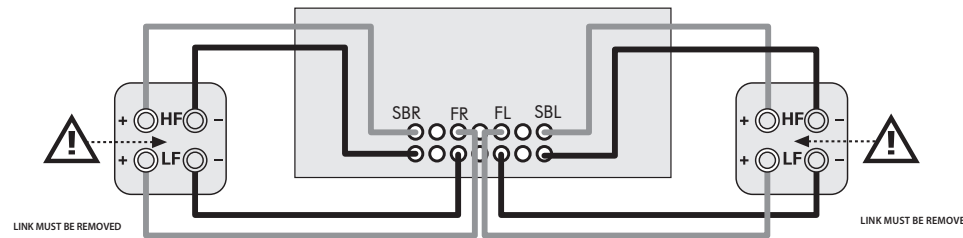

## Connecting subwoofers

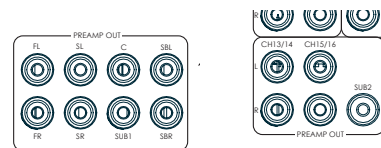

The Receiver also allows up to four active subwoofers to be connected to the **SUB** or **Ch13/14/15/16** outputs. Refer to your subwoofer handbook for the correct setting up and connection procedure for your particular subwoofer(s).

## Using external power amplifiers

The internal power amplifier of the Receiver can be supplemented or replaced with external power amplification, such as the JBL Synthesis SDA-7120 or SDA-2200. Connect the **PREAMP OUT** sockets to your power amplifier inputs:

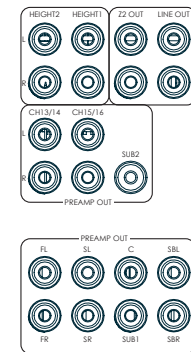

### FL, FR

Connect these to the equivalent Right and Left front channels of your power amplifier.

### C

Connect these to the Center front channel of your power amplifier.

### SUB

Subwoofer outputs. Connect this to the input of your active subwoofer(s), if present.

### SR, SL

Surround Right and Surround Left outputs. Connect these to the Surround Right and Left power amplifier inputs.

### SBR, SBL

Surround Back Right and Surround Back Left outputs. Connect these to the Surround Back Right and Surround Back Left power amplifier inputs.

### Height 1 (Height Front), Height 2 (Height Back)

Height Front and Height Back. Connect these to the Height channel power amplifier inputs.

All preamplifier analog outputs are buffered, have a low output impedance and are at line level. They are able to drive long cables or several inputs in parallel if required.

## Operation

### Operating your Receiver

For information display we recommend you use the OSD (On-Screen Display) on your display device whenever possible. For set up and configuration we recommend accessing the internal webpage using a tablet or computer, or using the front panel display.

For more information on accessing the internal set up page visit [www.jblsynthesis.com](http://www.jblsynthesis.com).

### Switching on

Press the front panel power button in. The power LED will glow white. When initialization is complete, the display shows the volume setting and the name of the selected input.

Please wait until the unit has finished initializing before operating the Receiver. It is recommended that if the unit is switched off, you should wait at least 10 seconds before switching the unit back on.

### Standby

The Receiver has a standby mode which can be entered by pressing **STANDBY** on the remote control. When in standby mode, the display is blank and the **POWER** LED glows red.

If the unit is to be left unused for an extended period, we recommend that you disconnect it from AC power to save power.

### To switch on from standby

Press the **STANDBY** button on the remote control, any key on the front panel (other than the power button) or rotate the volume knob.

### Front panel display

The Receiver is ready for use after about four seconds.

The display window shows the currently selected source and the last selected information view setting (this information line can be changed using the **INFO** button).

The current volume setting for Zone 1 is displayed on the front panel. The volume setting for Zone 2 is displayed temporarily whenever it is adjusted.

The front panel display is also used for unit setup after pressing the **MENU** key on the front panel or remote.

### Selecting a source

To select a particular source, press the **INPUT-** or **INPUT+** buttons until that source is shown on the front panel display, or (if available) press the corresponding source button on the remote. The following sources are available:

STB	Set Top Box input
GAME	Game console input
AV	Audio-Visual input
SAT	Satellite input
BD	Blu-ray Disc/DVD player input
UHD	UHD player input
PVR	Personal Video Recorder input
CD	Compact Disc player input
FM	Internal tuner input
DAB	Internal tuner input (this source is market dependent and may not be available on your Receiver)
NET	Ethernet input
USB	External USB solid-state device (e.g. pen drive) input
AUX	Auxiliary (front panel) input
DISPLAY	The Audio Return Channel (eARC) from a compliant display. Use this with a compliant television using internal TV tuners.

Most audio inputs have both analog and digital connections. You must specify the type of connection used for each input using the '**Audio Source**' option in the 'Input Config' menu, see page EN-31. Note that an incorrect setting will result in no sound — the default for inputs with HDMI is HDMI audio. If you are not using HDMI audio then this setting must be changed. For inputs that do not have HDMI, the default is digital audio.

The processing mode and Stereo Direct functions are remembered and recalled for each individual input.

### Stereo Direct

To listen to a pure analog stereo input, press the **DIRECT** button. The Stereo Direct mode automatically bypasses all processing and any surround functions. In direct mode, digital processing including Dirac room eq, is shut down if desired. Digital noise within the processor will be reduced to an absolute minimum.

**NOTE: When Stereo Direct mode is selected, no bass management is performed, meaning that bass signals will not be redirected to a subwoofer.**

### Volume control

It is important to realize that the level of the volume indicator is not an accurate indication of the power delivered to your loudspeakers. The Receiver often delivers its full output power long before the volume control reaches its maximum position, particularly when listening to heavily recorded music. In comparison, some movie sound tracks can appear very quiet, as many directors like to keep maximum levels in reserve for special effects sequences.

### Headphones

To use headphones with the Receiver, plug the headphones into the **PHONES** jack in the center of the front panel.

When headphones are plugged into the front panel **PHONES** socket, the outputs for Zone 1 are muted and the audio will be down-mixed to two channels (2.0). The two-channel down-mix is required so that the center channel and surround information can be heard via the headphones.

## Extended front panel menu

Pressing the **MENU** key on the front panel and holding it for longer than four seconds will bring up the Extended Menu, allowing you to perform the following:

### Restore to factory defaults

This option allows you to restore all settings on your Receiver to the defaults from which it left the factory.

### Check for update

Checks for an over-the-air firmware update (requires external network connection).

### Restore secure backup

This option allows you to restore all settings to their state as saved using the 'Store secure backup' feature. This option is useful if settings are accidentally changed.

### Store secure backup

This option allows you to save all the Receiver settings to a secure area of memory. The settings can be retrieved using the Restore option above.

### Restore USB backup

This option allows you to restore all the settings from a file previously saved on a USB flash drive.

### Store USB backup

This option allows you to save all the settings to a USB flash drive.

### Region

Sets the region you are located - Europe, (RoW) US or Canada.

### Change remote code

The default RCS system code the Receiver responds to is 16. If required, for example due to another device in your system also using this RCS system code, it can be changed to 19. The supplied remote can also be reprogramd to use RCS system code 19 commands, see page EN-22.

### Standby mode

"Auto" uses the power-saving auto-standby feature, which will cause the unit to go into standby after 20 minutes if no signal is present or user input occurs, "manual" allows the user full control of when the unit goes into standby.

### Protection sensitivity

This option allows adjustment of the protection sensitivity of the power amplifier (not SDP-55). Caution should be used with this setting as it is deliberately configured for maximum protection and should only be adjusted when using speakers that are "complex loads"!

### Use display HDMI

If set to "no" the Receiver will ignore the EDID of the display and send all resolutions from the source through the Receiver.

### Display type

Adjusts the position of the OSD depending on if a 16:9 & 21:9 display is being used.

## Updating firmware via USB

The firmware in your Receiver can be updated from a USB flash drive containing firmware update files.

You can download the latest firmware file, together with upgrading instructions, from the JBL Synthesis website ([www.jblsynthesis.com](http://www.jblsynthesis.com)).

# Front Panel Operation

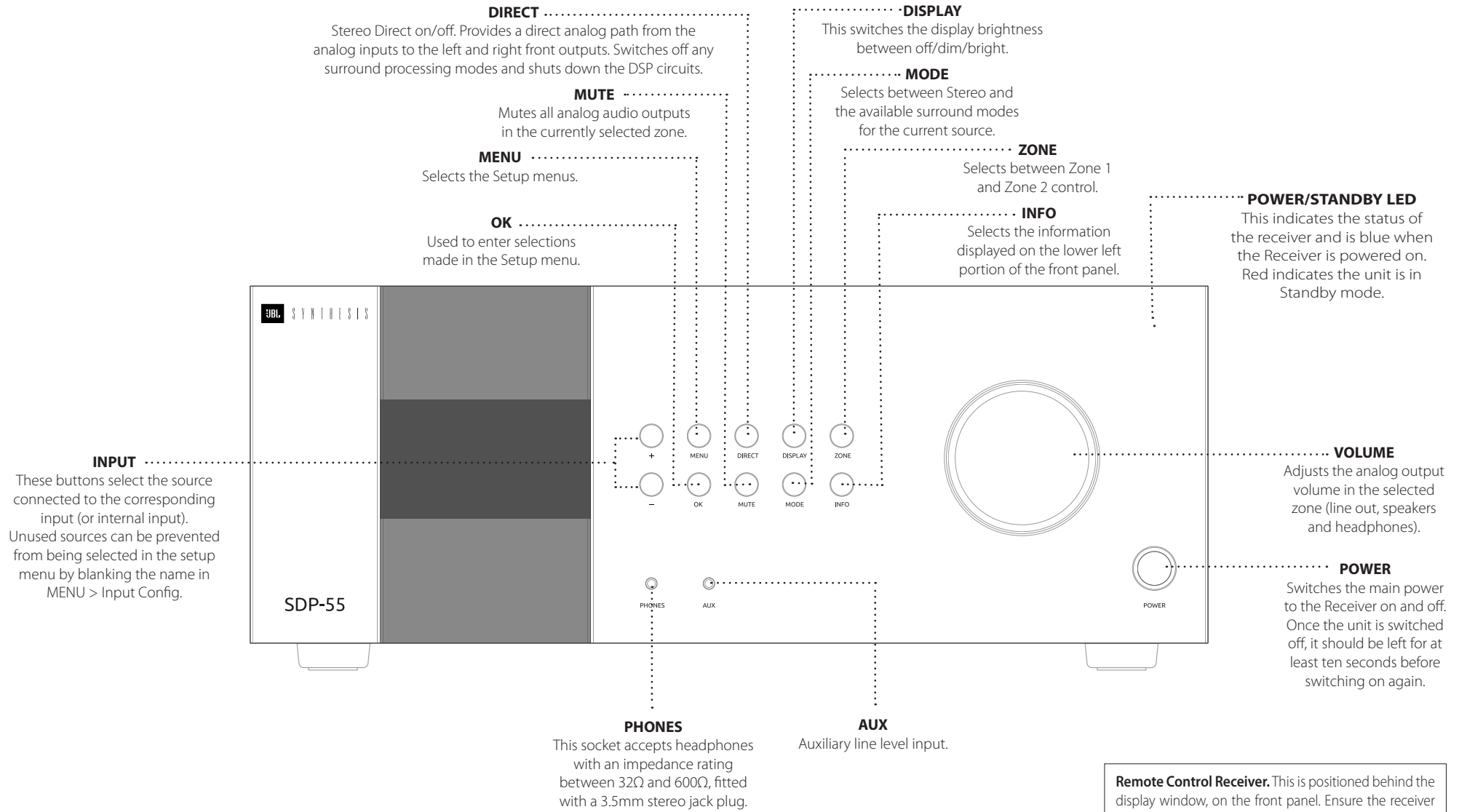



# Remote Control

## The universal remote controller

The Receiver is supplied with a sophisticated 'universal' backlit remote control that can control up to eight devices. It is pre-programmed for use with the Receiver and many other Harman products (FM/DAB tuners, CD players and BD players).

With its extensive built-in library of codes, it can also be used with thousands of third party audio-visual components – TVs, satellite and set-top boxes, PVRs, CD players, etc. See the list of codes at the back of this handbook.

It is also a 'learning' remote, so you can teach it almost any function from an old single-device remote.

## Using the remote control

Please keep in mind the following when using the remote control:

- Ensure there are no obstacles between the remote control and the remote sensor on the Receiver. The remote has a range of about 25 feet. (If the remote sensor is obscured, the Z1 IR remote control input jack on the rear panel is available. Please consult your dealer for further information.)
- Remote operation may become unreliable if strong sunlight or fluorescent light is shining on the remote sensor of the Receiver.
- Replace the batteries when you notice a reduction in the operating range of the remote control.



## Inserting batteries into the remote control

1. Open the battery compartment on the back of the handset. To do this, press the catch on the battery cover as indicated by the arrow on the catch and remove the battery cover.
2. Insert two 'AAA' batteries, as indicated in the battery compartment.
3. Replace the battery cover. To do this, locate the lug on the battery cover into the corresponding hole on the short edge of the battery compartment. Now press the opposite end of the battery cover (with the catch) down so that the cover is flush with the main body of the remote and the catch clicks.

## Notes on batteries:

- Incorrect use of batteries can result in hazards such as leakage and bursting.
- Do not mix old and new batteries together.
- Do not use non-identical batteries together – although they may look similar, different batteries may have different voltages.
- Ensure the plus (+) and minus (-) ends of each battery match the direction indicated in the battery compartment.
- Remove batteries from equipment that is not going to be used for a month or more.
- When disposing of used batteries, please comply with governmental or local regulations that apply in your country or area.

## Useful information

### Backlight

A backlight comes on for eight seconds whenever a key is pressed. This helps you use the handset in subdued lighting conditions.

### LED blinks

Short blinks indicate a valid key press.

Multiple short blinks convey information (such as a device code) or signal the beginning and successful completion of a programming sequence.

The symbol  is used in the manual to indicate an LED blink.

### Timeouts and unassigned keys

**Timeout** – After 30 seconds the remote exits the programming state and returns to normal operation.

**Stuck key timeout** – After any key is pressed continuously for 30 seconds, the remote stops sending IR transmission to conserve battery life. The remote remains off until all keys are released.

**Unassigned keys** – The remote ignores any unassigned key presses for a particular Device Mode and does not transmit IR.

### Low voltage indicator

When the batteries are running down, the backlight flashes briefly whenever you press a button. If this happens, fit two new AAA alkaline batteries as soon as possible.

## Device Mode/Source keys

As the remote can control your Receiver as well as a range of other equipment: many of the buttons have more than one function depending on the 'device mode' selected on the remote control.

The Device Mode keys (shown below) select the source on the Receiver. If one of these keys is pressed briefly, a command is transmitted to change the source on the unit. Also the functionality of the remote control changes to operate the selected source device; it's like having a bundle of different remotes in your hand!



	Internal FM or DAB tuner input
	Auxiliary input
	Ethernet input (e.g. Internet radio)
	Bluetooth input
	Audio-visual input
	Satellite input
	Personal Video Recorder (or Digital Video Recorder) input
	Games console input
	Blu-ray Disc or DVD player
	Compact Disc player input
	Set Top Box decoder input
	UHD player input

Each Device Mode changes the behaviour of many of the remote keys to control the source device appropriately. For example: in **CD** mode plays the previous CD track, but in **AV** mode issues the TV 'channel down' command.

The remote remains in the last selected Device Mode so it is not necessary to press a Device Mode key before every command key if all you are doing is playing or skipping tracks on a CD, for example.

## Navigation keys



The Navigation keys steer the cursor in Setup menus or on-screen menus. They also replicate the navigation functions of original remotes supplied with other home entertainment devices in your system. **OK** confirms a setting.

## Volume control

By default, the remote is set up so that the volume control and mute buttons always control the volume of the Receiver, regardless of which Device Mode the remote is currently set for. This is known as volume 'punch through'.

For example, if you are listening to a CD, you will probably have the remote in **CD** Device Mode to control the CD player. You can use the volume controls on the remote directly to adjust the volume of the Receiver without first having to press **AMP** to put the remote into **AMP** Device Mode. The volume buttons 'punch through' the **CD** Device Mode on the remote to the **AMP** Device Mode.

Volume 'punch through' can be disabled individually for any Device Mode if desired.

## Customising the remote

The remote offers a Code Learning feature that allows you to copy up to 16 functions from an original remote control onto the remote keypad. For details of this, and other customisation features, see "Customising the Remote" on page EN-22.

## The remote complies with Part 15 of the FCC rules

This equipment has been tested and found to comply with the limits for a class B digital device, pursuant to part 15 of the FCC Rules. These limits are designed to provide a reasonable protection against harmful interference in a residential installation. This equipment generates, uses, and can radiate radio frequency energy and if not installed and used in accordance with the instructions, may cause harmful interference to radio communications. However, there is no guarantee that interference will not occur in a particular installation. If this equipment does cause harmful interference to radio or television reception, which can be determined by turning the equipment off and on, the user is encouraged to try to correct the interference by one or more of the following measures:

- Reorient or relocate the receiving antenna.
- Increase the separation between the equipment and receiver.
- Connect the equipment into an outlet or a circuit different from that to which the receiver is connected.
- Consult the dealer or an experienced radio/TV technician for help.

# Customizing the Remote

## Code learning

The supplied remote comes with a complete library of pre-programmed codes. After you have set up the remote for your device, you may find that there are one or more functions on your original remote which do not have a place on the keypad. For convenience, the remote offers a Code Learning feature that allows you to copy up to 16 functions from an original remote control onto the remote keypad.

### Before you start, make sure that:

- The original remote control is working correctly.
- The remotes are not pointing at your device.
- The remotes have fresh batteries.
- The remotes are not in direct sunlight or under strong fluorescent lights.

**NOTE: Learned functions are mode-dependent. You could assign up to eight different functions to a single key – a separate learned function for each mode.**

### Direct code setup (Method 1)

The first method is to program the remote with the 3-digit code number for the device you wish to control – see “device code tables”. Make a note of the suggested number or numbers – the most popular code is listed first. Now power on the device.

1. Press the Device key for the product you want to set up, together with the **1** key. Hold down both buttons for three seconds until the LED stays lit.

You are now in setup mode, and you can release the buttons.

2. Enter a 3-digit code for the device.





If the 3-digit code number you entered is correct for the device, it will turn off. If it doesn't turn off, enter the next code number from your list until the device does turn off.

3. Once you have found the correct code, press the Device key again. The LED blinks three times  to confirm that the code has been successfully stored.

### Library search setup (Method 2)



Library search allows you to scan through all the codes contained in the remote's memory. It can take a lot longer than the previous method, so only use this method if:

- Your device does not respond to the remote after you have tried all the codes listed for your brand.
- Your brand is not listed at all in the Device Code tables.

1. Press the Device key for the product you want to set up, together with the **1** key. Hold down both buttons for three seconds until the LED stays lit.
2. Point the remote control at the product you wish to control and press the  or  button on the navigation pad. Each time the  or  button is pressed, the code counts up (or down) one code number with a signal to power off the device.
3. Continue pressing the up or down button, in approximately one second intervals, until the device turns off. (DO NOT alternate the up and down button – you need to move in only one direction.)
4. To store the correct code, press the Device key again. The LED blinks three times  to confirm that the code has been successfully stored.

### Learning setup (Method 3)

The third method involves ‘teaching’ the JBL Synthesis remote from the original remote for the device. The two remotes should be facing each other, about 4 inches (10cm) apart.

1. Press the Device key for the product you want to set up, together with the **3** key. Hold down both buttons for three seconds until the LED stays lit.
2. Press the button on the JBL Synthesis remote that you want to assign a command to. The LED blinks once  indicating that the remote is ready to learn the command.
3. Press and hold the appropriate key on the other remote until the LED blinks twice . This indicates the JBL Synthesis remote has learned the command from your other remote.
4. Continue learning the commands from your other remote by pressing the next button on the remote and repeating steps 2 and 3.
5. Once the remote has learned all the selected commands, press and hold the Device key you used to enter learning together with the Numeric **3** key to store the learned commands.

**NOTE: If the JBL Synthesis remote LED blinks five times  there was an error in the learning process. In this case, please start the Learning Setup from the start.**





**The AMP and RADIO keys do not learn commands.**

### Important notes

- Once you start a Code Learning session, you have approximately ten seconds to conduct each step. Any longer, and a timeout means that you'll have to start the process again.
- The Learning feature is mode-specific – you can copy one feature **per mode** onto a key.
- The remote can learn approximately 16 functions in total.
- To replace a learned function, simply assign a new function to the same key.
- Learned functions are retained when you change batteries.
- If Code Learning fails, try altering the distance between the two remotes; make sure that the ambient light is not too bright.



## Deleting the learned data

**To delete all the learned data for a device:**





1. Press the Device key for the product you want to set up, together with the **3** key. Hold down both buttons for three seconds until the LED stays lit.
2. Press and hold down the Device key for the product that you want to erase, together with the **11** key for three seconds until the LED blinks twice .
3. If no further key presses are made for 30 seconds after the LED blinks twice , the remote leaves erase mode without deleting the learned data.
4. If you press the Device key together with the **3** key one more time within 30 seconds after LED blinks twice , you can finish the erase mode deleting all the data learned on the Device. The LED blinks three times  to confirm.

**NOTE**  
On the following pages, a single 'blink' of the remote's power LED is indicated by the symbol .

### To delete the learned data for a key for a device:

1. Press the Device key for the product you want to set up, together with the **3** key. Hold down both buttons for three seconds until the LED stays lit.
2. Press and hold down the key on which you want to delete the data for three seconds. The LED blinks twice . If any further key press is made, the remote escapes from erase mode without deleting the learned data.
3. If any further key press is not made for 30 seconds, the LED blinks twice , the remote escapes from the erase mode automatically without deleting the learned data.
4. If you press the Device key together with the **3** key again within 30 seconds after the LED blinks twice, all the data learned for that Device is deleted and you leave erase mode. The LED blinks three times  in confirmation.

### Reading stored code numbers

1. Press the Device key for the product that you want to set up together with the **4** key. Hold down both keys for three seconds until the LED blinks.
2. Press the **INFO** key and count the number of blinks (=1, =2, =3, etc.). There is a time gap between digits. (Note that '0' is represented by ten blinks: .)

### Locking/unlocking a specific Device Mode

When you first unpack your remote and insert the batteries, it is able to control certain JBL Synthesis components automatically (e.g. BD players, Amplifiers, Tuners and CD Players). We achieve this by programming specific JBL Synthesis device codes onto the relevant Device Mode keys, then locking the Device Modes so you don't reprogram them inadvertently.

If you want to override these locked default settings – to control a third-party BD player, for example – you will first need to unlock BD Mode before setting up the remote using one of the learning methods described on the previous page.

Here are the factory default settings:

Device Mode	Default status	Default codes
<b>AMP</b>	Locked	001 (JBL Synthesis code 16)
<b>BD</b>	Locked	001 (JBL Synthesis)
<b>AV</b>	Unlocked	108 (Philips TV)
<b>UHD</b>	Unlocked	Code learning only
<b>GAME</b>	Unlocked	Code learning only
<b>STB</b>	Unlocked	030 (Bush/Goodmans/Grundig, from SAT database)
<b>SAT</b>	Unlocked	128 (Sky+ Digital, from SAT database)
<b>PVR</b>	Unlocked	018 (Humax PVR, from SAT database)
<b>CD</b>	Locked	001 (JBL Synthesis)

Alternative codes are available for multi-room solutions, or in the case of code clashes with other manufacturer's products.

For example:

**AMP** (system code 19): 002

Note that you need to change the system code on the product you wish to control, as well as the remote.

1. **AMP**, **BD** and **CD** are the Device keys that may be Locked or Unlocked.  
Lock and Unlock are toggles (they change from Lock to Unlock to Lock, etc.).
2. Press and hold the Device and **6** keys together for three seconds.  
The power LED stays lit, showing that it is in Lock/Unlock setup mode.
3. If there is no further key input for 30 seconds, the LED goes off and the remote leaves Lock/Unlock setup mode.
4. To toggle the status of a device and then verify the status of a device, press the **3 6 9** keys in sequence:

If you have locked the device, the LED blinks three times: .

If unlocked the device, the LED blinks five times: .

5. If you press a valid Device key within 30 seconds, the LED blinks three times:  and the remote leaves Lock/Unlock setup mode.

### Controlling the volume of other devices

By default, the volume keys and mute key control the amplifier volume.









You can configure these buttons so they send volume commands to another device. In the following example, the volume commands are sent to a linked AV device (your television, for instance):

1. Press **AV + 5** for three seconds, until the LED lights and stays on.
2. Press **VOL UP**.
3. Press **AV** again. The LED blinks three times .

The volume and mute keys will now send the volume commands to the TV.



To set the volume buttons to control the amplifier once more, repeat the above steps, except press **AMP** in step 3.

### Hidden commands

Command	Effect
<b>AMP + </b>	Sends a Power On command
<b>AMP + </b>	Sends a Power Off command
<b>AMP + OK</b>	Sends a Zone command
<b>AMP + </b>	Cycles through HDMI outputs 1, 2, 1&2.
<b>CD + </b>	Sends a Power On command
<b>CD + </b>	Sends a Power Off command
<b>BD + </b>	Sends a Power On command
<b>BD + </b>	Sends a Power Off command
<b>BD + </b>	Sends a Resolution command

### Factory default reset

You can reset your remote to the original factory default settings.

Press and hold both the  (home) and **MENU** keys for about five seconds until the power LED blinks five times .

All programming and setup codes that you have entered into the remote are erased and the remote returns to the original factory default settings.

### Device codes

The tables that are in the final section of this Handbook list 3-figure codes for different manufacturers' devices.

Use these when setting your remote up to control your devices, as described in Direct code setup: Method 1 (see previous page).

If more than one code number is listed, try the first number. If the results are unsatisfactory, continue trying the numbers for that manufacturer to get the best 'fit' with the functionality required.





If the manufacturer of your equipment is not listed, you can try Library search setup: Method 2 (see previous page). This method allows you to scan through every code contained in the remote's memory.



AMP







## AMP Device Mode

The **AMP** Device Mode button configures the remote to control the Receiver. Pressing this button does not affect the currently selected input on the Receiver.

The functionality of the remote is context sensitive for the internal sources and is described in the following table.





	<b>Single press</b> – Toggles Receiver power between standby and on in the current zone (zone in which the command is received). <b>Press and hold</b> – Forces all zones into standby, regardless of which zone the command was received in.
0.....9	The number keys can be used for direct entry of numeric values
SYNC	Sync. Delays may be introduced into the video signal by video processing which causes a mismatch between the audio and video timing. You will notice this by speech sound being out of synchronization with the lip movements in the video. To compensate for this, you can adjust the lip sync delay. Press the <b>SYNC</b> button and use the  and  navigation buttons. Press again to exit the lip sync trim menu.
INFO	Info cycles through the information displayed on the lower left portion of the front panel display when on <b>TUN, NET</b> and <b>USB</b> inputs.
	Brings up the DTS:X dialog control adjustment.
MENU	Displays the unit's setup menu on the On Screen Display.
POP UP	Toggles Dolby Volume on/off.
AUDIO	Toggles Dirac Live EQ on/off.

RTN	Brings up a temporary subwoofer trim control. Use the  and  navigation buttons. Press <b>RTN</b> again to exit the sub trim control. As this is a temporary adjustment, the sub trim level is reset to the value set in the Speaker Levels menu when the unit is turned off or put into standby.
	Toggles the mute function of the AVR.
VOL	Adjust amplifier volume.
MODE	Cycles through the available surround and downmix modes.
DISP	Cycles through the front panel display's brightness options
AMP	Resets remote to <b>AMP</b> mode.
DIRECT	Stereo direct on/off. Provides a direct analog path from the analog inputs to the left and right front outputs. Switches off any surround processing modes and shuts down the DSP circuits.

	Navigate the files and menus on the screen. <b>OK</b> selects the highlighted file or enters the highlighted menu on the screen – equivalent to 'Enter' or 'Select' on some remote controls.  Up  Left  Right  Down <b>AMP</b> +  Power on from standby <b>AMP</b> +  Standby from Power on <b>AMP</b> + <b>OK</b> select Zone 2
RED	Red button.
GREEN	Green button.
YELLOW	Yellow button.
BLUE	Blue button.
RADIO	Tuner input.
AUX	Aux input.
BT	input.
USB	USB input.
AV	AV input.
SAT	SAT input.
PVR	PVR input.
GAME	Game console input.
BD	BD input.
CD	CD input.
STB	STB input.
UHD	UHD input.

## Network commands









When using the network client, the keys below are used to navigate music files in **AMP** Device Mode.









	Navigates the files on screen. <b>OK</b> selects/plays the highlighted file.
	Selects the previous/next track in the current playlist.
	Pause and playback of the current track.
	Stops playback.
RED	Adds the currently displayed radio station to the favourites list when using the network client.
GREEN	Removes the currently displayed radio station to the favourites list when using the network client.
	Returns navigation to the top level of the network client menus ('Home')

BD

## BD/DVD Device Mode

The **BD** Device Mode button configures the remote to control the functions of Harman Blu-ray Disc and DVD players, although this can be changed. Pressing this button also selects **BD** as the source.





	Toggles power between standby and on.
	Open/close disc tray.
0..9	Searches for and plays the track corresponding to the key pressed when playing a CD.
DISP	Cycles through the front panel display's brightness options.
MODE	Cycles through the repeat options (track, disc, etc.).
	Fast rewind.
	Fast forward.
	Press and release to skip back to the beginning of the current/previous track.
	Press and release to skip forwards to the beginning of the next track.
	Stop playback of a BD or DVD.
	Pause and playback of the current track.
	Start recording (on products that have this feature).
MENU	Disc menu.
POP UP	Activates BD/DVD player menu, if available.

	Navigate setup and BD/DVD program selection menus. <b>OK</b> selects the highlighted file or enters the highlighted menu on the screen – equivalent to 'Enter' or 'Select' on some remote controls.  Up  Left  Right  Down <b>BD</b> +  Power on from Standby <b>BD</b> +  Standby from Power on <b>BD</b> +  changes the picture resolution (for BD, only on the Home screen).
	Returns navigation to the top level of the menu ('Home').
AUDIO	Changes audio decode format (Dolby Digital, DTS, etc.).
AMP	Resets remote to <b>AMP</b> mode.
RED	<b>RED</b> button for BD
GREEN	<b>GREEN</b> button for BD
YELLOW	<b>YELLOW</b> button for BD
BLUE	<b>BLUE</b> button for BD.

AV

## AV Device Mode

The **AV** Device Mode button configures the remote to control the functions of a television or other display device. You will need to configure this Device Mode to work with your equipment. Pressing this button also selects **AV** as the source.

	Toggles power between standby and on. (Some TVs require you to use a number key to turn them on).
0..9	Functions as original remote number key – usually for channel selection.
DISP	Display INFO or OSD (On Screen Display) function, if available.
MODE	AV; this function is TV specific.
	Channel down.
	Channel up.
INFO	Displays picture information; this function is TV specific.
POP UP	Guide.
	Navigate setup and program selection menus. <b>OK</b> confirms a selection (equivalent to 'Enter' or 'Select' on some remotes).
	Returns navigation to the top level of the menu ('Home').
AMP	Resets remote to AMP mode.
RED	<b>RED</b> key for Text TV
GREEN	<b>GREEN</b> key for Text TV
YELLOW	<b>YELLOW</b> key for Text TV
BLUE	<b>BLUE</b> key for Text TV.

UHD

## UHD Device Mode

The **UHD** Device Mode button selects **UHD** as the source.











The UHD page allows code learning from a dedicated UHD remote – see "Customising the Remote" on page EN-22

## STB

### STB Device Mode

The **STB** Device Mode button selects **STB** as the source.

If configured to work with your set top box decoder or similar device, the remote can subsequently control the device.





	Toggles power between standby and on.
0..9	Functions as original remote number key – usually for channel selection.
DISP	Display INFO or OSD (On Screen Display) function, if available.
MODE	Selects the Library or Media function.
	Rewind.
	Fast Forward.
	Channel down.
	Channel up.
	Stop playback.
	Pause and playback of the current track.
	Record.
INFO	Opens the EPG (Electronic Program Guide) on some satellite and cable set top boxes.
POP UP	Turns on the Menu function if the set top box uses this feature.
	Navigate setup and program selection menus. <b>OK</b> confirms a selection (equivalent to 'Enter' or 'Select' on some remotes).
	Returns navigation to the top level of the menu ('Home').
AUDIO	Selects the Help function.
AMP	Resets remote to AMP mode.
RED	<b>RED</b> button for set top box.
GREEN	<b>GREEN</b> button for set top box.
YELLOW	<b>YELLOW</b> button for set top box.
BLUE	<b>BLUE</b> button for set top box.

## SAT

### SAT Device Mode

The **SAT** Device Mode button selects **SAT** as the source.

If configured to work with your satellite receiver, the remote can subsequently control the device.









	Toggles power between standby and on.
0..9	Functions as original remote number key – usually for channel selection.
DISP	Display INFO or OSD (On Screen Display) function, if available.
	Channel down.
	Channel up.
INFO	Displays program information.
POP UP	Guide (or Setup on some set top boxes).
	Navigate setup and program selection menus. <b>OK</b> confirms a selection (equivalent to 'Enter' or 'Select' on some remotes).
	Returns navigation to the top level of the menu ('Home').
RTN	Back.
AMP	Resets remote to AMP mode.
RED	<b>RED</b> button for Satellite.
GREEN	<b>GREEN</b> button for Satellite.
YELLOW	<b>YELLOW</b> button for Satellite.
BLUE	<b>BLUE</b> button for Satellite.

## PVR

### PVR Device Mode

The **PVR** Device Mode button selects **PVR** as the source.

If configured to work with your personal (hard disc) video recorder or similar device, the remote can subsequently control the device.

	Toggles power between standby and on.
0..9	Functions as original remote number key – usually for channel selection.
INFO	Display INFO or OSD (On Screen Display) function, if available.
MODE	Selects the Library or Media function.
	Rewind.
	Fast Forward.
	Channel down.
	Channel up.
	Stop playback.
	Pause and playback of the current track.
	Record.
MENU	Opens the EPG (Electronic Program Guide) on some satellite and cable set top boxes.
POP UP	Turns on the Menu function if the PVR uses this feature.
	Navigate setup and program selection menus. <b>OK</b> confirms a selection (equivalent to 'Enter' or 'Select' on some remotes).

	Returns navigation to the top level of the menu ('Home').
AUDIO	Selects the Help function.
AMP	Resets remote to AMP mode.
RED	<b>RED</b> button for PVR.
GREEN	<b>GREEN</b> button for PVR.
YELLOW	<b>YELLOW</b> button for PVR.
BLUE	<b>BLUE</b> button for PVR.

CD

**CD Device Mode**

The **CD** Device Mode button selects **CD** as the source.  
 The button is configured to control the CD functions of JBL Synthesis CD players, although this can be changed (see "Locking/Unlocking a specific Device Mode" on page EN-23).

	Toggles power between standby and on.
	Open/close disc tray.
0...9	Searches for and plays the track corresponding to the key pressed.
DISP	Cycles through the front panel display's brightness options.
MODE	Cycles through the repeat options (track, disc, etc.).
	Fast rewind.
	Fast forward.
	Press and release to skip back to the beginning of the current/previous track
	Press and release to skip forwards to the beginning of the next track.
	Stop playback of a CD
	Pause and playback of the current track.
POP UP	In 'normal play' (i.e. the display does not show the letter <b>P</b> ), press the  and  keys to select the track and then <b>MENU</b> stores the track. In 'program play' mode, the <b>MENU</b> key deletes the stored track.

	Navigate setup and CD program selection menus. <b>OK</b> selects the highlighted file or enters the highlighted menu on the screen – equivalent to 'Enter' or 'Select' on some remote controls. Up Left Right Down <b>CD</b> +  Power on from Standby <b>CD</b> +  Standby from Power on.
AMP	Resets remote to <b>AMP</b> mode.
RADIO	Plays the program tracks.



# Essential Setup

Before you use your Receiver it is essential that you enter some information into the Setup menus about your speaker configuration. This allows the Receiver to process any surround sound digital source to exactly match your system and give you the ultimate surround sound experience.

There are three pieces of vital information which are outlined in the sections: 'Speaker Types', 'Speaker Distances' and 'Speaker Levels'.

The way you enter this information manually into the Receiver is given later in the 'Setup Menus' section on page EN-30.

When calibrated using Dirac Live room equalization the speaker levels and delays will be established automatically and applied when the equalization is turned on, speaker types however must be manually entered. For use with equalization turned off, the speaker size, speaker distance and speaker levels settings must be entered manually. It is important to understand why these speaker settings must be entered, which is why this section is presented before the section on equalization.

## Speaker types

You need to set the type of speakers that you have connected to your Receiver:

<b>Large</b>	capable of full frequency range reproduction
<b>Small</b>	not capable of full frequency range reproduction at the low frequency end
<b>None</b>	speaker not present in your configuration

The terms 'Large' and 'Small' do not necessarily relate to the physical size of your speakers. As a rule of thumb, if a speaker cannot reproduce a flat frequency response down to about 40Hz (and very few can!) it is often better to consider them as 'Small' for setup purposes of home cinema.

When a speaker is set to 'Small', very low frequency sounds are redirected away from that speaker to a 'Large' speaker or a subwoofer, which are far better suited to reproducing these low frequency sounds. Many prefer to set even very full-range speakers to 'Small' to optimize the dynamic range of the system and to more fully utilize the Dirac Live Bass Management room EQ.

Note that it is not possible to set all speakers to 'Small' unless there is a subwoofer in your speaker configuration. If you do not have a subwoofer, you will be forced to set your front speakers to 'Large'.

(Some users may wish to automatically override the 'Small' speaker setting for purely stereo music listening when not watching movies. This can be achieved in the 'Input Config' menu – see page EN-31.

### Crossover frequency

If you have set any speakers as being 'Small', then you will be required to set a value for the crossover frequency. This is the frequency below which signals are filtered away from these Small speakers and redirected to 'Large' speakers or the subwoofer (if present). 80 Hz is usually the best crossover frequency, since it sends non-directional low frequencies to the subwoofers which are best-suited to handle low frequencies and can be placed optimally to reproduce only the lowest frequencies.

A Certified JBL Synthesis Calibrator will select the appropriate settings during the calibration process.

### Use Channels 6+7 for

If not used in the main zone, it is possible to assign the Surround Back channels to Height 1, bi-amp the Front Left/Right channels or to provide an amplified output to Zone 2.

## Speaker Levels

Finally the levels of all the speakers in the system need to be adjusted to match each other at the listening position, to create a proper surround effect. To help with this the Receiver can generate a test noise for each speaker which should be measured with a sound pressure level (SPL) meter. The meter should be set to 'C' weighting and slow response. Several smartphone/tablet apps are available which can also perform this function. The level of noise measured at the listening position from each speaker should be adjusted on the Speaker Trims page of the 'Setup' menu so that the meter reads 75dB SPL. It does not matter what the system volume setting of the Receiver is before turning the test noise on as the volume setting is over-ridden for the duration of the speaker noise test.

**NOTE: Mobile phone apps are limited in accuracy unless an external microphone is used. Consult your dealer for recommendations.**

There are several basic SPL meters on the market at reasonable prices aimed at home cinema enthusiasts. Check your local technology store, search online or ask your dealer.

If you do not have an SPL meter or suitable app, you can try to adjust the noise level of each speaker by ear. In this case it is not possible to adjust the speakers to the absolute 75dB SPL volume level, but you should aim for all speakers sounding equally loud. Setting speaker test noise levels by ear is not recommended as it is very difficult to do accurately. A Certified JBL Synthesis Calibrator will ensure all levels are set properly.

## Speaker Distances

It is essential for the distance from each speaker to the listening position to be accurately measured and entered into the 'Setup' menu. This ensures that the sounds from the various speakers arrive at the listening position at the correct time to recreate a realistic surround effect. The distance can be entered in centimeters or inches.

## Auto Speaker Setup



### Dirac Live with Bass Management

There is a proprietary automatic loudspeaker calibration function built into your Receiver from Dirac Research. Using a PC/MAC based application, this attempts to set the essential speaker settings for all the speakers in your system. It also calculates room equalization (Room EQ) filter values to remove some of the worst effects of resonant frequencies in the listening room.

Your Receiver package is supplied with a basic calibration microphone, which should be inserted into a USB port on a PC or MAC connected to the same network as the Receiver and positioned as directed by the Dirac Live PC/MAC application. This microphone picks up the special calibration tones generated by the speakers when Dirac Live application is run. Optionally, a high quality, calibrated third-party microphone can be used for greater accuracy, such as the miniDSP UMIK-1. The Receiver then analyzes the signal and computes:

- speaker delays,
- speaker level,
- problem resonant frequencies in the room which need control by filtering.

To help the system be as accurate as possible when performing Dirac Live setup, there are a few guidance rules that should be followed:

- Minimize any background sounds in the listening room and other nearby rooms.
- Close all windows and doors in the listening room.

- Turn off all fans including air-conditioning systems.
- Mount the microphone on a tripod or similar.
- Position the set up microphone pointing upwards at roughly head height when placed in the normal listening position. It is not necessary to point the microphone directly at the speaker generating the test tone, the microphone should be pointing vertically towards the ceiling. (It helps if you are able to position the microphone exactly where your head would normally be for listening, with the microphone in direct unobstructed view of all speakers.) Assure all objects, such as chair backs are at least *18 inches (46cm)* away from the microphone. Ideally, move the seating away during measurements to prevent reflections that can reduce the accuracy of the equalization.
- If your system includes an active subwoofer, start by setting its output level/gain control to a value roughly matching the front speakers.

Although Dirac is designed to make the calibration process easier, a certified JBL Synthesis Calibrator has the training and tools to maximize performance results.

### Problems

We advise you to look over the reported measurements on the screen following Dirac Live setup for any obviously incorrect results, in particular to ensure the reported speakers match your configuration and that the speaker distances to the listening position appear look roughly correct. If the results are not what you expected re-run Dirac Live setup.

The Dirac Live setup function is normally quite accurate but occasionally false results can be generated. Problems may be as a result of:

- external sounds or rumbling/handling noises picked up by the microphone
- sound reflections off hard surfaces (e.g. windows or walls) close to the listening position,
- very strong acoustic resonances within the room,
- obstacles (such as a sofa) between speakers and the microphone.

If you are still experiencing difficulties or you wish to have the most accurate results for ultimate surround performance, we recommend using the manual method of establishing speaker distances and levels.

### Using subwoofers

If your system includes active subwoofers you may need to set the subwoofer output level/gain control set to a higher or lower value.

Please refer to the Dirac application and quick start guide for full details of how to use the system with your Receiver.

### Downloading the Dirac Live application

To download the Dirac Live PC/MAC application and quick start guide, please visit: [live.dirac.com](http://live.dirac.com)

### Using Dirac

You can store up to three Dirac EQ curves in the Receiver. Each input can use a different curve, for example a "Movie" curve on the BD input and "Music" curve on the CD input.

This can be set on a per input basis using the **AUDIO** key on the remote.

Alternatively use the Room EQ menu item in the Audio settings menu to set the curve for each input. See "Room EQ" on page EN-31.

***NOTE: When Dirac is run for the first time the curve will be applied to all inputs. Subsequent curves will not be automatically applied; use the methods above to choose the required curve for the input in question.***

# Setup Menus

The Setup menus allow you to configure all aspects of your Receiver. The next few pages will go through the menu items accessible via the front panel, IR remote, or internal web page and explain their function. The majority of the Setup menus need only be configured once when you first install the system (or if your system changes, you move any large furniture or the listening locations, or you move).

## Entering Setup mode

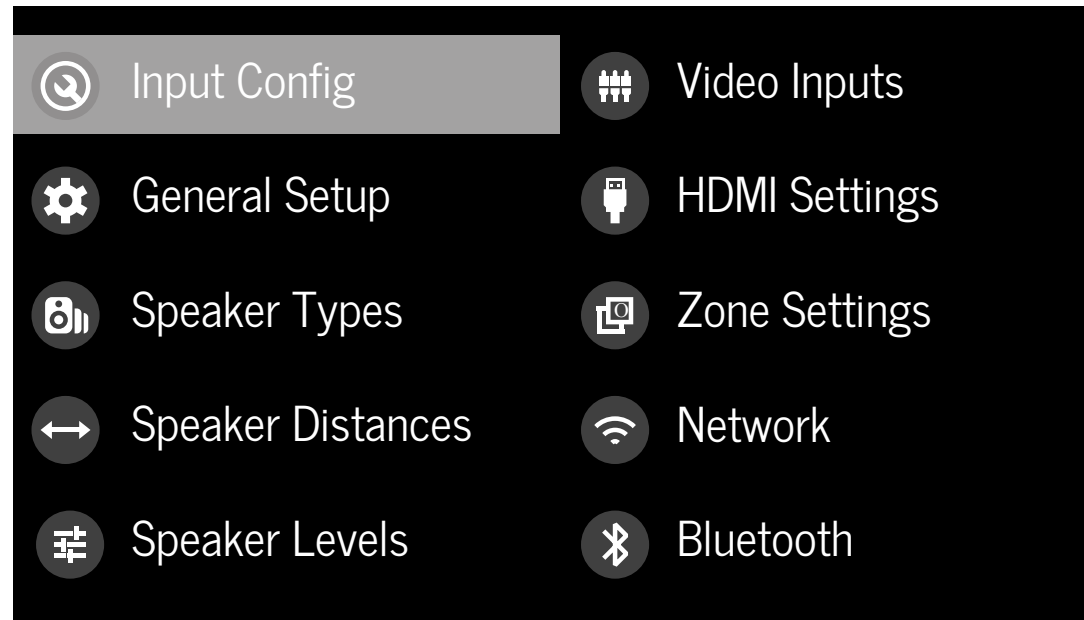

To enter the setup menu, press the **MENU** button on the remote control or front panel. The front panel display shows the setup menu (pictured right).





## Navigating the setup menu

### ... using the remote control

The setup menu can be navigated by using the cursor (arrow) keys on the remote control. This is by far the easiest method.

1. To enter the setup menu, press the **MENU** button (which is located immediately under the navigation buttons).
2. Use the  and  keys to navigate up and down the main section headings.
3. Once you have the main section that you require highlighted, use the  key to enter the section.

4. Use the  and  keys to navigate up and down the section settings in the right-hand panel. Some settings may be greyed out. These are either for information only (e.g. incoming sampling frequency) or are not currently selectable. Scroll bars on the sides of the right hand panel indicate your position in the settings list where there are more items than can be displayed at once.

5. Pressing **OK** selects a setting to change it, pressing **OK** again de-selects the setting.
6. At any time, press the **MENU** button to exit the menu. Any changes to settings are saved.

### ... using the keys on the front panel

The Receiver front panel controls can be used to configure the unit. Follow the instructions for using the remote control, in this case using **INPUT-** for down, **INPUT+** for up, **INFO** for left and **MODE** for right.

### ...using the internal configuration web page

The units have an internal configuration page that presents the same set up functionality front panel display on a web browser.

This enables the unit to be set up and configured from any browsing device connected to the same network as the unit.

To access the internal configuration page, find the units' IP address by selecting **Network > IP Address**. Type the IP address in the browser window.

The menu headings and function are the same in the internal configuration page and the front panel and are described below.

## Input Config.

The audio and video settings on this page of the Setup menu can be tailored **specifically and independently for the currently selected input.**

When a different input is selected on the Input line, all the input-specific settings for that input are displayed below it. These settings are applied to the named Input only and are stored in memory and recalled each time the unit is powered up and whenever that input is selected.

**Input** – The currently selected input connectors to which the settings below relate.

**Name** – The display name of the input. You can change the name of any input to more closely match your setup. For example, if you had two satellite receivers, you could connect the main receiver to the SAT audio and video input connectors and change the Name to 'SAT 1'. You could then connect the second satellite receiver to the UHD audio and video input connectors, but change the UHD Name to 'SAT 2'. It is then clearer to users of your Receiver which inputs they wish to select when scrolling through.

**Lip Sync** – Each input can have its own setting to add a time delay between the audio and video signals to compensate for the sound and picture not being synchronised. This is normally required when video processing is used in the system for scaling or de-interlacing video. The range of lip sync delay is 0 to 250 milliseconds.

The lip sync adjustment can only correct for delayed video. If the audio is late set lip sync to its minimum.

**Mode** – Sets the initial audio decode mode for stereo sources on this input.

- Last Mode recalls the last used setting for this input when a stereo source was applied. See section "Two-channel source modes" on page EN-35 for more information.

- **MCH. Mode** – Sets the initial audio decode mode for multi-channel digital sources on this input.

- Last Mode recalls the last used setting for this input when a stereo source was applied. See section "Multi-channel source modes" on page EN-35 for more information.

### Bass –

#### Treble –

These allow you to alter the bass and treble tone controls for all currently active speakers for each individual input. For example, if your PVR source sounds a little bass light, you can always correct for this by selecting PVR on the Input line at the top of this menu and add 2 or 3dB to the Bass control. Then, whenever the PVR input is selected, the bass is automatically boosted for as long as that input is selected.

**Room EQ** – When the Dirac Live Bass Management application is run and EQ filters are downloaded into one of the three slots available, this can be selected.

- **Not Calculated:** (Information only) There are no EQ filters, so cannot be selected.
- **Project Name:** Dirac Live Room EQ is applied to the current source and will display the name of the project from the Dirac Live application.
- **Off:** Dirac Live Room EQ is not applied to the current source.

**Input Trim** – Sets the maximum analog input signal level (sensitivity) on this input before the ADC (Analogue-to-Digital converter) signal path clips. Options are 1, 2 and 4 volts RMS maximum input. The default is 2Vrms maximum.

For example, analog sources with low output levels may benefit by choosing the 1V maximum setting. This helps maximize signal-to-noise performance of the Receiver and also helps keep the various analog sources sounding about the same level for any given Receiver volume control setting.

**Dolby Volume** – Dolby Volume is an intelligent system that improves the perceived audio frequency response at lower listening levels and corrects for volume inconsistencies between sources (e.g. a rock radio station and a BD) and between programming (e.g. a TV show and advertisement breaks).

**On:** Dolby Volume is applied to this input.

- **Off:** (default) Dolby Volume is not applied to this input.

**Dolby Leveller** – This setting of Dolby Volume controls how closely quiet and loud sources and program content are matched to each other, based on the ear's perception of loudness. The range of values is 0 (minimal levelling) to 10 (maximum levelling). The default setting is 2, however we recommend experimenting with higher values if your source material is less closely matched in level. If the Volume Leveller function is set off, no level matching between sources and program material is performed. Note however that turning the Dolby Leveller setting of Dolby Volume to 'Off' is not the same as turning the entire function of Dolby Volume to 'Off', as volume related frequency response processing is still active.

**DV Calib. Offset** – The Calibration Offset parameter of Dolby Volume allows you to compensate for speaker efficiencies and listening position. The default value is 0 and this should normally produce a good result when the Receiver speaker levels are set using a sound pressure level meter.

**Stereo Mode** – If you have configured your system to have a subwoofer, then you have the flexibility to choose how bass information is distributed between the front left/right speakers and the subwoofer when listening to stereo (two channel only) analog and digital sources. Choose the option which gives you the most solid, even sounding bass. If you are using a subwoofer for stereo, please also see Sub Stereo below to set the level of the subwoofer. For best results test with a setup disc unless Dirac EQ is active on the input. This setting can be used to override your normal speaker settings in the Spkr Types menu whenever the Receiver plays stereo material. It is quite common to some people find that two channel stereo music listening is best done with a slightly different sub/speaker setting than for surround movies.

- **As Spkr Types:** When an analog or digital stereo source is played, your normal speaker configuration (as in **Spkr Types** menu) is used to reproduce the signal.

- **Left/Right:** This setting provides a full-range 2-channel signal. All audio is sent to the front left and right speakers only without any bass redirection. You can use this setting if you consider your front left/right speakers to be able to handle the full frequency range of music. If you have set your front left/right speaker size as Small in the Spkr Types setup page, you may wish to use this option to override the setting to Large for stereo music listening, if you have full frequency range left/right speakers. It can often be beneficial to set full frequency range speakers to Small in the Spkr Types setup page for use with movies, if you have a subwoofer in your system. Doing so may deliver more impact on movie soundtracks as subwoofers are designed to handle reproduction of high bass content. However some listeners may find that for stereo music a better overall result is obtained by not using the subwoofer and effectively treating the front left/right speakers as Large.

- **Left/Right+Sub:** Full frequency range stereo is fed to the front left and right speakers and extracted bass is sent to the subwoofer. In this case the low frequency information is effectively duplicated which may result in unpredictable and colored low frequency reproduction. This setting is not recommended for accurate sonic reproduction.

- **Sat+Sub:** Use this setting if you really do have Small satellite front left and right speakers, or if you prefer the overall sound of bass being handled by the subwoofer. Full bass management is used so that analog and digital stereo sources are fed to the DSP where the bass is filtered off front left and right and redirected to the subwoofer.

**NOTE: The Stereo Mode function is not available when using an analog source in Stereo Direct mode.**

**Sub Stereo** – If Left/Right+Sub or Sat+Sub is selected in Stereo Mode above, this setting adjusts the level of the subwoofer when the source is two channel stereo.

**IMAX Mode** – Selects if IMAX mode is enabled from the incoming audio stream (auto) or forced on or off.

**Auro-matic 3D** – Selects the mode of the Auro-matic 3D upmixer.

**Small:** Adjusts the upmixer for a small-sized room.

- Medium:** (default) Adjusts the upmixer for a medium-sized room
- Large:** Adjusts the upmixer for a large-sized room.
- Movie:** Adjusts the upmixer for film material.
- Speech:** Adjusts the upmixer to focus on speech intelligibility.

**Auro-matic 3D Strength** – Adjusts the ratio of unprocessed-to-processed signal when using the Auro-Matic 3D upmixer.

**Audio Source** – Selects the particular connection type for each input. The default is HDMI for inputs with an HDMI connection and Digital for inputs without an HDMI connection. This setting must be changed if another connection is used.

Select from the list the audio type you are using on this source.

- HDMI:** the unit is forced to use the HDMI audio input for this source.
- Digital:** the unit is forced to use the optical (**TOSLINK**) or coaxial (**S/PDIF**) digital audio input for this source
- Analogue:** the unit is forced to use the analog audio input for this source.

**CD Direct** – Turns off the compressed audio detection mute delay and should only be used for sources that will only transmit PCM audio (e.g. a CD player).

## General Setup

General information and system controls.

**Source Input** – (Information only) The currently selected input to which the settings below relate.

**Incoming Format** – (Information only) The format of the digital audio stream connected to this input, if present.

**Incoming Sample Rate** – (Information only) The sample rate of the digital audio stream connected to this input, if present.

**Incoming Bit Rate** – (Information only) The bit rate of the digital audio stream connected to this input, if present.

**Dialnorm** – (Information only) If a Dolby Digital audio stream is connected to this input, this is the Dialog Normalization setting requested by the stream.

**Incoming Resolution** – (Information only) Shows the incoming video resolution.

**Audio Compression** – Allows selection of compression which is desired for late night listening. The compression effect increases the volume of the quiet passages and decreases the volume of the louder passages. Compression only applies to Dolby/DTS soundtrack formats that support this function.

- Off:** (default) no audio compression is applied.
- Medium:** compression is applied so that loud portions of a soundtrack are reduced in level. Any Dolby True HD stream is compressed automatically as set by the incoming stream.
- High:** the maximum amount of dynamic range compression is applied, so that the difference between loud and quiet portions of a soundtrack is minimized.

This setting applies to all inputs when a relevant digital audio stream is detected. It is stored in memory and recalled each time the unit is powered up.

**Balance** – To alter the sound balance temporarily between front left and right speakers. You can alter the sound stage to either the left or the right by up to 6dB. Note that it is not possible to shift the audio signal completely over to one channel. This function resets to equal left/right balance when the input is changed.

**Dolby Center Spread** – Allows adjustment of the sound field for Dolby Surround mode decoding of two-channel sources. With Dolby Surround decoding, dominant center signals come only from the center speaker. If no center speaker is present, the decoder splits the center signal equally to the left and right speakers to create a 'phantom' center image. The Center Spread control allows variable adjustment of the center image so it may be heard only from the center speaker; only from the left/right speakers as a phantom image, or from all three front speakers to varying degrees.

**DTS Dialog Control** – Sets the level of the dialog channel in compatible DTS audio streams.

**Maximum Volume** – Limits the maximum volume setting the system can be turned up to in the main zone. This is a useful feature to prevent accidental overdriving of low power-handling speakers (for example). It is stored in memory and recalled each time the unit is powered up.

**Max On Volume** – Limits the maximum volume the system operates in the main zone when it is switched on or comes out of Standby. The system comes on at this stored volume setting if the last used (possibly very loud) volume exceeds this value. It is stored in memory and recalled each time the unit is powered up.

**Display on time** – Sets the time that the front panel display remains illuminated after receiving a command. The default is always on.

**Control** – Enables or disables RS232 or IP (NET) control, a system that allows control from various third-party home automation systems. Note, only RS232 or IP control can be used, not both.

**Power on** – Determines how the unit powers on.

- Stby:** in Standby mode
- On:** On
- Last state:** Last state (default).

**Language** – Select the language for the setup menu – English, French, German, Spanish, Dutch, Russian, Chinese.

## Speaker Types

Settings for the types of loudspeaker you have connected in your configuration. These settings are applied to all audio inputs and are stored in memory and recalled each time the unit is powered up.

**Front Left/Right** –

**Center** –

**Surr. Left/Right** –

**Surr. Back L/R** –

**Height Front** –

**Height Back** –

Here you set the type of speakers that you have connected to your Receiver:

- Large:** capable of full frequency range reproduction
- Small:** not capable of full frequency range reproduction at the low frequency end
- None:** speaker not present in your configuration

---

**NOTE: It is not possible to set all speakers to Small unless there is a subwoofer in your speaker configuration. If you do not have a subwoofer, you will be forced to set your front speakers to Large.**

---

**Subwoofer** – configures if the dedicated Sub Out connectors, "Sub1" and "Sub2" are used for a single subwoofer channel. (Either connector may be used.) For systems with two or more subwoofers, use channels 13, 14, 15 & 16 for up to four independent subwoofers, which can fully utilize Dirac Live Bass Management.

**Channel 13 & 14** –

**Channel 15 & 16** –

Configures the speaker positions that channels 13, 14, 15 & 16 are used for.

**Height Type** – configures the type of height speakers - ceiling mounted or Dolby enabled.

**Use Channels 6+7 for** – If your main zone speaker set up does not include Surround Back Left and Right speakers, you can choose to use the Surround Back amplifier channels as the Height 1 amplifiers, to Bi-Amp the Front Left and Right pair, or as a stereo power amplifier for Zone 2.

**Filter Slope** – Configures the filter slope used for bass management - 12dB, 24dB, 36dB, 48dB/octave.

**Sub Gain** – configures the output level trim for all outputs configured as subwoofers in -6dB steps from 0dB to -30dB.

## Speaker Distances

Calibration settings for the distances between the loudspeakers and the listening position.

---

**NOTE: Speakers that are not present in your configuration will be greyed out.**

---

If Dirac Live is used, these settings will be shown in time (mS) and not distance.

These settings are applied to all audio inputs and are stored in memory and recalled each time the unit is powered up.

**Units** – Select whether you wish to measure distances in imperial or metric units.



**Front Left** –  
**Center** –  
**Front Right** –  
**Surr. Right** –  
**Surr. Back Right** –  
**Surr. Back Left** –  
**Surr. Left** –  
**Left Top Front** –  
**Right Top Front** –  
**Left Top Back** –  
**Right Top Back** –  
**Subwoofer** –  
**Channel 13** –  
**Channel 14** –  
**Channel 15** –  
**Channel 16** –

As described in “Essential Setup” on page EN-28, measure the distance from each loudspeaker in your system to your ear in the main listening position and enter the values. This allows the Receiver to calculate the correct relative delay for each loudspeaker.

## Speaker Levels





These settings allow adjustment of individual speaker levels if Dirac Live has not been used for setup. They should be adjusted using either internally generated test noise or an external source, such as a setup test disc.

**NOTE: Speakers that are not present in your configuration will be greyed out.**

These settings are applied to all audio inputs and are stored in memory and recalled each time the unit is powered up.

**Test Tone** – selects the internal test tone generator or allows the use of an external test tone from the currently selected HDMI input (e.g. played from a BD).

**Front Left** –  
**Center** –  
**Front Right** –  
**Surr. Right** –  
**Surr. Back Right** –  
**Surr. Back Left** –  
**Surr. Left** –  
**Left Top Front** –  
**Right Top Front** –  
**Left Top Back** –  
**Right Top Back** –  
**Subwoofer** –  
**Channel 13** –  
**Channel 14** –  
**Channel 15** –  
**Channel 16** –

Use the  and  navigation buttons on the remote control to select the relevant speaker. Press  to enable/disable the calibration noise and the  and  navigation buttons to adjust the noise level from each speaker.

As described in “Essential Setup” on page EN-28, adjust the level of the test noise from each speaker so that an SPL meter at the listening position measures 75dB SPL.

## Video Inputs

Settings to optionally assign a video source to each of the normally audio-only inputs.

These settings are stored in memory and recalled each time the unit is powered up.

**Video Input CD** –  
**Video Input Aux** –  
**Video Input FM** –  
**Video Input DAB** –  
**Video Input Net** –  
**Video Input BT** –

The default for each of the audio inputs is ‘None’. You could, however, associate ‘Sat’ video with FM or Digital Radio audio to receive radio commentary of a sports game with pictures from satellite coverage, for example.

## HDMI Settings

The settings in this menu control the output resolution from the video processor in the Receiver. These settings are applied to all video inputs and are stored in memory and recalled each time the unit is powered up.

**Zone 1 OSD** – Selects whether the main zone pop-up OSD messages are On or Off. It is stored in memory and recalled each time the unit is powered up.

- When **On**, all user adjustments that are made during the general use of the Receiver are displayed on screen as well as the front panel display. This includes the adjustment of volume, subwoofer level, lip sync, tone controls, etc. It is stored in memory and recalled each time the unit is powered up.
- When **Off**, the above user adjustments will not appear on screen, only on the front panel display. This leaves the picture on your display device clear of pop-up text. However, regardless of this setting the Setup menus are always displayed on screen.

**Zone 1 Out** – This setting controls the output for zone 1 from either output1, output2 or both.

**Zone 1 Lipsync** – (Information only) Displays how much lip sync is automatically applied to the HDMI output to

compensate for video processing delays in the attached display device. Not all display devices support this function.

**HDMI Audio to TV** – This setting controls the audio being sent direct to the TV.

**HDMI Bypass & IP** – This setting controls the functionality of HDMI bypass & IP control while in standby. Selecting “Low Power” (default) will mean that IP control (network) and HDMI bypass are disabled. Selecting “HDMI & IP On” means that IP Control (network) & HDMI bypass is enabled.

**HDMI Bypass Source** – Selects which input is used for HDMI bypass function, either a specific input or the last input used.

**CEC Control** – Selects if CEC control is enabled on output 1.

**eARC Control** – This setting enables/disables volume control from the display.

**TV Audio** – This setting enables/disables auto-switching to eARC audio from the display.

**Power Off Control** – This setting enables/disables auto-power control from other CEC-enable devices.

## Zone Settings

Lists the volume and control settings for Zone 2. These settings are applied to all audio inputs and are stored in memory and recalled each time the unit is powered up.

**Z2 Input** – Selects the input to be routed to Zone 2. The default is ‘Follow Z1’, i.e. the same source as currently selected in Zone 1.

**Zone 2 Status** – Selects if Zone 2 is in Standby or On.

**Zone 2 Volume** – The current volume in Zone 2.

**Zone 2 Max. Vol** – Limits the maximum volume setting the system can be turned up to in the Zone 2. This is a useful feature to prevent accidental overdriving of low power-handling speakers, for example.

**Zone 2 Fixed Vol** – The Zone 2 volume control can be locked at the current value for use with an external amplifier with its own volume control in Zone 2.

**Zone 2 Max On Vol** – Limits the maximum volume the system operates in the Zone 2 when it is switched on or comes out of Standby. The system comes on at this volume if the last used (possibly very loud) volume exceeds this value.

# Connecting to a Network

## Network

The Receiver is fitted with a network audio client which is capable of Airplay 2, and Google Chromecast built-in as well as stored music on a network storage device such as a PC, or on NAS drive.

The wireless network is configured using the Apple Airplay setup or the Google Home app.

**SSID** – (Information only) Displays the SSID the receiver is currently connected to, “wired” if a wired connection is used, or “not connected” if no connection is present.

**IP Address** – (Information only) IP address assigned by the DHCP server, or if not using DHCP, the IP address you have assigned to the Receiver for your network.

**MAC address** – (Information only) The unique address of the network card in your Receiver.

**Friendly name** – (Information only) The network “friendly name” of your Receiver.

## Bluetooth

The Receiver is fitted with a Bluetooth audio input.

**Pair Device** – Makes the Receiver discoverable by Bluetooth devices.

**Clear Paired Device List** – Clears the Receiver’s list of paired Bluetooth devices..

**Paired Devices** – Displays a list of the devices paired with the Receiver.

In order to use the Airplay and ChromeCast functionality of the Receiver you will need to connect it to your home network via a wireless or wired connection.

The following sections detail how to do this.

**Note:** Before attempting to setup a wireless connection ensure the supplied wireless antennas are fitted to the antenna sockets on the rear of the Receiver.

## Home Automation Control

When connected to a network the Receiver can be controlled and monitored remotely using dedicated home automation software.

The same controls are also available via the RS232 input.

Various third-party systems are available providing sophisticated control over all your entertainment devices. Contact your dealer or installer for details. The technical details of the remote control protocol are available upon request, by contacting JBL Synthesis at [csupport@harman.com](mailto:csupport@harman.com)

For details of the available controls please refer to the control document which can be found at [www.jblsynthesis.com](http://www.jblsynthesis.com) for further information.

## Airplay Setup

### Wired Connection

Connect an ethernet cable to the Receiver.

To listen to audio via Airplay on your Receiver, ensure your Apple device is connected to the same network as the Receiver and simply select the Receiver as the Airplay audio playback device.

**Note:** The Receiver will appear as JBL modelname-xxxxxx in the Airplay speaker menu, where xxxxxx is the last 6 digits of the units MAC address.

### Wireless Connection

Ensure your Apple device is connected to the wireless network you wish to connect the Receiver to.

Open the Wi-Fi settings menu on the Apple device and select the Receiver from the “Set up new airplay speaker” menu.

Follow the instructions on screen. To listen to audio via Airplay on your Receiver, ensure your Apple device is connected to the same network as the Receiver and simply select the Receiver as the Airplay audio playback device.

**Note:** The Receiver will appear as JBL SYNTHESIS modelname-xxxxxx in the Airplay speaker setup menu, where xxxxxx is the last 6 digits of the units MAC address.

## ChromeCast Built-In Setup

### Wired Connection

Connect an ethernet cable to the Receiver.

**Note:** The Receiver will appear as JBL modelname-xxxxxx in the playback menu, where xxxxxx is the last 6 digits of the units MAC address.

### Wired & Wireless Connection

Download and open the Google Home application.

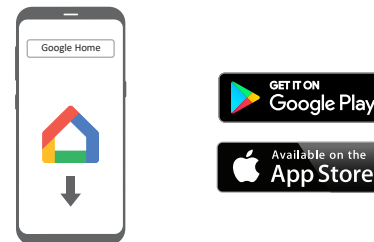

You should be prompted that there is a device available for setup. If not simply tap “Add” followed by “Setup a Device”.

Select the Receiver and follow the instructions on screen.

To listen to cast audio from any supported application on your Receiver, ensure your device is connected to the same network as the Receiver. Tap the ChromeCast built-in icon from within the application and select the Receiver as the playback device.

**Note:** The Receiver will appear as modelname-xxxxxx in the setup menu, where xxxxxx is the last 6 digits of the units MAC address.

## Decoding Modes

### Introduction

Your Receiver provides all the key decoding and processing modes for analog and digital signals, including the latest high definition audio formats over HDMI.

### Modes for digital sources

Digital recordings are usually encoded to include information about their format type. The Receiver automatically detects the relevant format in a digital signal – such as Dolby Atmos, TrueHD, Dolby Digital Plus, DTS:X, DTS-HD Master Audio, Auro 3D, Dolby Digital, or DTS – and switches to the appropriate decoding.

### Modes for analog sources

Analog recordings do not contain information about their encoding formats, so the desired mode – such as Dolby Surround – needs to be selected manually.

### Mode memory

Dolby Digital or DTS audio (including the high definition formats) can be output in two mix modes, selected using the **MODE** button:

- Surround (e.g., five main channels plus a subwoofer for a 5.1 source)
- Stereo downmix.

Two-channel audio, regardless of whether it is analog or digital can also be output in two mix modes, selected using the mode button:

- Surround (e.g., Dolby Surround, DTS Neural:X, etc.)
- Stereo.

The Receiver stores the settings for each source. Thus the decoding mode for the following groups of source material can be stored independently:

- Dolby Digital (multi-channel) and DTS source material
- Two channel Dolby, PCM or Analogue source material

### Two-channel source modes

The following decoding and surround modes are for creating multi-channel stereo modes from 2-channel sources. They are available on the Receiver for standard and high definition Dolby Digital 2.0, DTS 2.0, PCM or analog sources:

*Stereo –*

*16 Channel Stereo –*

*Dolby Surround –*

*Dolby Virtual Height -*

*DTS Neural:X -*

*DTS Virtual:X -*

*Auro-matic 3D -*

### Stereo

In this mode the Receiver works as a conventional high quality audio amplifier. Note that if the subwoofer is enabled in stereo mode, then some processing of the signal is carried out.

- Stereo Direct:** this achieves the most direct signal path if an analog connection is present.
- 16 Channel Stereo:** this produces an output from all speakers by copying the left output to all left speakers and the right output to all right speakers. The center speaker outputs a mix of left and right.

### Dolby Surround

Dolby Surround allows the Receiver to derive up to 16 outputs from a two or multi-channel source to take better advantage of all amplifiers and speakers in your setup.

### Dolby Virtual Height

Dolby Virtual Height creates an immersive audio experience by virtualising height content over traditional speaker configurations without the need for height speakers. Note - this mode is NOT available if height speakers are selected.

### DTS Neural:X

DTS Neural:X is an advanced up-mixer that renders up to 7.1.4 channels of immersive audio from nearly any lower channel count content.

### DTS Virtual:X

DTS Virtual:X creates an immersive audio experience by virtualising height content over traditional speaker configurations without the need for height speakers. Note - this mode is NOT available if height speakers are selected.

### Auro-matic 3D

Auro-matic 3D creates an immersive audio experience by creating additional channels from the incoming audio to match the available output channels, enhancing the listening experience.

### Logic 16

Logic16 is an advanced up-mixer which produces astonishingly natural three-dimensional sound. Designed by Harman research scientists and engineers, Logic 16 will up-mix any input source from mono up to 15.1, including all Dolby formats.

### Multi-channel source modes

For many years, digital multi-channel source material was often provided as '5.1 audio'. The '5.1 channels' are comprised of: left, center and right front speakers, two surround speakers and a low frequency effects (LFE) channel. Since the LFE channel is not a full range channel, it is referred to as '1'.

Dolby Atmos, DTS:X, DTS-HD, Auro 3D are high-resolution immersive surround formats which use object oriented audio technology to deliver additional sonic locations for the sound requiring additional speakers including height (ceiling) speakers. The SDR-35 and SDP-55 natively decode 9.1.6, where the last number (.6) represents the height speakers.

### Decoding modes

The modes given in the following table are available for multi-channel digital sources.

Special modes such as DTS-ES 6.1 discrete, Dolby Digital Plus, Dolby TrueHD, Dolby Atmos, DTS:X, DTS-HD and IMAX® ENHANCED, Auro 3D are only available from the correct source material.



<b>High resolution audio sources</b>	
Dolby Atmos	Dolby Atmos content is mixed as audio objects instead of traditional channels, so can take full advantage of the number and placement of your speakers.
Dolby TrueHD	Provides up to 7.1 full channels at 96kHz, 24bit resolution, with no losses in the compression process. Data rates can be up to 18Mbps.
Dolby Digital Plus	Provides up to 7.1 discrete channels of audio with less compression than traditional Dolby Digital encoding. Data rates can be up to 6Mbps.
DTS-HD Master Audio	Provides up to 7.1 full channels at 96kHz, 24bit resolution, with no losses in the compression process. Data rates can be up to 24.5Mbps.
DTS:X*	<p>DTS:X is a decoder package that renders immersive content which has been encoded with DTS:X encoding. DTS:X content consists of audio objects or a combination of audio channels and objects. The DTS:X decoder package also plays back legacy DTS formats including DTS-HD Master Audio lossless and lossy streams.</p> <p>Supports greater than 7.1 channel output configurations (including height speakers)</p> <p>Provides "Dialog Control" so consumers can adjust the sound to their preference or the listening environment</p> <p>Remaps any DTS content to any speaker layout</p> <p>Supports Blu-ray Disc (BD), DVD and streaming media formats, and legacy streams up to 192kHz.</p> <p>Includes Neural:X, the latest upmixing/downmixing technology from DTS.</p>
IMAX ENHANCED	IMAX® Enhanced products meet the highest level of standards, ensuring the best color, contrast, clarity and sound on the market. These are products endorsed by IMAX to fully deliver the most immersive at-home entertainment experience and leverage the full quality and scale of IMAX Enhanced content. The IMAX Enhanced program introduces a new standard in home entertainment.
AURO 3D	AURO 3d is a decoder package that renders the audio at three levels - ear level, height level and the "Voice of God" level, creating an immersive sphere of audio.

<b>For Dolby Digital sources</b>	
Dolby Digital 5.1	Dolby Digital 5.1 sources deliver sound with five discrete full-range channels; left, center, right, surround left, surround right, plus LFE channel.
Dolby Digital Stereo Downmix	Provides a stereo downmix of the source material for use with headphones.
Dolby Digital 5.1 + Dolby Surround	This mode is used to derive information for the individual surround back channels from the surround channels, using the Dolby Surround decoder.
<b>For DTS sources</b>	
DTS 5.1	Less common than the Dolby Digital format, but generally recognized within the audio industry as being of superior sound quality. DTS 5.1 delivers surround sound with five full range channels plus an LFE channel.
DTS 5.1 Stereo Downmix	Provides a stereo downmix of the source material for use with headphones.
DTS-ES 6.1 Matrix	This is a 6.1 channel format based on DTS 5.1. It has the sixth channel matrix encoded into the surround left and surround right channels. The sixth channel is a surround center channel and is directed to the surround back left and surround back right speakers.
DTS-ES 6.1 Discrete	This is a true discrete 6.1 channel sound format. DTS-ES discrete mode operates only on sources with DTS-ES 6.1 discrete audio encoding.
DTS96/24	Provides up to 5.1 channels of audio at 96kHz, 24bit resolution for superior sound quality compared to standard DTS 5.1

## Tuner Operation

The Receiver is fitted with an FM/DAB/DAB+ (digital radio) tuner. DAB broadcasts are not available in all locations.

This section deals with tuner operation, for information on setting up the tuner and installing antennas, see page EN-13.

When a tuner input is selected, the OSD shows a list of radio presets plus an information panel giving all available information about the current frequency (for FM) or station (for DAB).



The front panel will also give the same information, pressing the **INFO** key will cycle through the various items of information:

<b>FM</b>
<input type="checkbox"/> Processing mode (default)
<input type="checkbox"/> Radiotext (if available)
<input type="checkbox"/> Program type (if available)
<input type="checkbox"/> Signal strength
<b>DAB</b>
<input type="checkbox"/> Processing mode (default)
<input type="checkbox"/> Radiotext (if available)
<input type="checkbox"/> Program type
<input type="checkbox"/> Signal quality
<input type="checkbox"/> Bit-rate of transmission

### Tuning/Channel Selection

When switching to the internal **TUNER** source, the Receiver enters the last used tuner band, be it FM or DAB. Repeatedly pressing **RADIO** cycles through the available tuner bands on your Receiver.

#### FM analog radio

Frequency tuning on FM radio is performed using the  and  buttons on the remote control in **TUN** device mode. Individual presses move the frequency down and up one step. If you press and hold either of the tuning buttons for two seconds, the tuner scans to the next strong signal. You can stop a scan at any time by pressing one of the tuning buttons again.

In Europe, the internal FM radio is capable of receiving RDS (Radio Data System) radiotext signals that are transmitted on some stations. The RDS information typically includes the radio station name, the music or speech genre as well as additional information related to the current program. On music stations this is often information on the currently playing track.





#### DAB digital radio

Digital Audio Broadcasting (DAB) radio is becoming more widely available.



See [www.worlddab.org/country\\_information](http://www.worlddab.org/country_information) for information on DAB availability.



You will need to scan for available stations before being able to listen to them.

To scan for DAB stations, first select the DAB tuner then press and hold  until the display indicates scanning has started. The Receiver will then scan all the DAB radio frequencies and compile a list of the stations that are available.



When the scan is complete, you can scroll through the station list using the  and  buttons on the remote control. To listen to the currently displayed station press the . If you do not press  within two seconds, the display will revert to displaying the currently playing station.

### Saving and Selecting Presets

Preset selection uses the  and  keys on the remote to browse and  to select the preset when the remote is in **TUN** device mode.

Up to 50 presets can be stored and these can be from any band, for example Preset 1 could be an FM station, preset two a DAB station, etc. Pressing the **OK** key causes the next available preset number to be displayed, then pressing the **OK** key again stores the current frequency/channel in that preset. If a different preset number is required, press the  and  keys until the desired number is displayed before pressing the **OK** key for a second time.

### Deleting Presets

When in tuner browse mode (using  and  to scroll through the presets), the yellow button on the remote is used to delete the currently highlighted (but not playing) station or frequency.

### MusicLife APP



The MusicLife™ app facilitates playback of your own music library stored on a computer, NAS drive, or USB flash drive.

# Troubleshooting

Problem	Check the following
There are no lights on the unit	<ul style="list-style-type: none"> <li><input type="checkbox"/> The power cord is plugged into the receiver and into the AC power outlet.</li> <li><input type="checkbox"/> The power button is pressed in.</li> <li><input type="checkbox"/> If a red LED is present, the receiver is in standby mode. Press any button on the front panel or the standby button on the remote control.</li> </ul>
The unit responds erratically or not at all to the remote control	<ul style="list-style-type: none"> <li><input type="checkbox"/> There are fresh batteries in the remote control.</li> <li><input type="checkbox"/> The front panel window is visible and you are pointing the remote control towards it.</li> </ul>
The front panel display is blank	<ul style="list-style-type: none"> <li><input type="checkbox"/> The display hasn't been turned off. Press the <b>DISPLAY</b> button on the front panel or remote control.</li> </ul>
No picture is being produced	<ul style="list-style-type: none"> <li><input type="checkbox"/> Your viewing device is turned on and switched to display your receiver. Test by pressing the <b>MENU</b> button on the receiver or on the remote and look for the main menu screen on your display device.</li> <li><input type="checkbox"/> The correct video input is selected on the receiver.</li> <li><input type="checkbox"/> The video source is on, is operating normally, and is in 'play' mode if appropriate.</li> </ul>
There are bright edges or 'ghosts' on the picture	<ul style="list-style-type: none"> <li><input type="checkbox"/> Ensure the 'sharpness' control on your display device is switched off or set to near minimum.</li> <li><input type="checkbox"/> For hdmi connections, try using a shorter cable or alternatively a different brand.</li> </ul>
No sound is produced	<ul style="list-style-type: none"> <li><input type="checkbox"/> The correct input has been selected.</li> <li><input type="checkbox"/> The '<b>audio source</b>' has been set correctly in the 'input config.' Menu</li> <li><input type="checkbox"/> The source equipment is on, is operating normally and is in 'play' mode if appropriate.</li> <li><input type="checkbox"/> The volume is turned up to a reasonable level and the receiver is not in mute mode.</li> </ul>
The sound is poor or distorted	<ul style="list-style-type: none"> <li><input type="checkbox"/> You have not excessively increased the input sensitivity (i.e. Reduced the maximum input signal voltage) in the input config. Menu if an analog input is being used.</li> <li><input type="checkbox"/> You have selected the correct size of speakers to suit your system in the setup menu.</li> </ul>

Problem	Check the following
Sound only comes from some of the speakers	<ul style="list-style-type: none"> <li><input type="checkbox"/> You have an appropriate surround source selected and playing.</li> <li><input type="checkbox"/> The BD/DVD disc is encoded in the appropriate format, and the correct format has been selected in the disc start menu of the bd player (if applicable).</li> <li><input type="checkbox"/> The BD/DVD player has been set to output 'bitstream' audio on the digital output.</li> <li><input type="checkbox"/> The display window indicates that the disc you are playing is a multichannel recording (you may need to press the <b>INFO</b> key several times until you get to the 'incoming format' display).</li> <li><input type="checkbox"/> All the speakers are correctly connected to the speaker terminals and are secure.</li> <li><input type="checkbox"/> You have not selected 'stereo' as the decoding mode.</li> <li><input type="checkbox"/> Your speaker balance is correct.</li> <li><input type="checkbox"/> You have configured the receiver to include all the speakers in your system.</li> </ul>
Unable to select Dolby or DTS decoding modes	<ul style="list-style-type: none"> <li><input type="checkbox"/> The receiver can only apply Dolby or DTS decoding to sources which have been encoded in the same format.</li> <li><input type="checkbox"/> Check that: <ul style="list-style-type: none"> <li><input type="checkbox"/> Digital source is selected and connected.</li> <li><input type="checkbox"/> The source is playing appropriately encoded material.</li> </ul> </li> <li><input type="checkbox"/> The BD/DVD disc is encoded in the appropriate format and that the correct format has been selected in the disc start menu of the bd player (if applicable).</li> <li><input type="checkbox"/> The BD/DVD player has been set to output 'bitstream' audio on the digital output.</li> </ul>
When playing a Dolby BD/DVD, the AV selects Dolby Surround	<ul style="list-style-type: none"> <li><input type="checkbox"/> You have a digital connection from your BD/DVD player.</li> <li><input type="checkbox"/> Sometimes dolby BD/DVD discs contain material at either the beginning or the end of the main movie that is not in full 5.1 Format, but in two-channel.</li> </ul>
Hum on an analog input	<ul style="list-style-type: none"> <li><input type="checkbox"/> All cables are making a good connection. If necessary remove the cable from the connector and plug it fully in again (turn the power off before doing this).</li> <li><input type="checkbox"/> The connections inside the source cable connector are not broken or badly soldered.</li> <li><input type="checkbox"/> If the hum originates only when one particular source component is connected, that an antenna cable, or satellite connection to this source is ground isolated. Contact your installation contractor.</li> </ul>

Problem	Check the following
There is radio or television reception interference	<ul style="list-style-type: none"> <li><input type="checkbox"/> Where the interference is coming from. Switch off each source component in turn, then any other equipment. Most electronic equipment does generate low levels of interference.</li> <li><input type="checkbox"/> Try re-arranging cabling from the nuisance source away from other cabling.</li> <li><input type="checkbox"/> Ensure that the cabling used is high quality, specified for its purpose, and is properly shielded.</li> <li><input type="checkbox"/> If the problem persists, contact your dealer.</li> </ul>
The source changes randomly or freezes on one source	<ul style="list-style-type: none"> <li><input type="checkbox"/> There are no static or impulse interference problems caused by nearby power equipment switching, such as heating or air conditioning control. Switch the receiver off, wait ten seconds, then switch it on again to clear an operating problem. Contact your installer if the problem returns or persists.</li> <li><input type="checkbox"/> There is no direct sunlight shining on the infra-red detector behind the front panel display.</li> </ul>
Volume is always too loud when I turn on	<ul style="list-style-type: none"> <li><input type="checkbox"/> The 'max on volume' setting is not set too high.</li> </ul>
If files on a NAS drive cannot be played	<ul style="list-style-type: none"> <li><input type="checkbox"/> The files are in a compatible format.</li> <li><input type="checkbox"/> The computer is connected via a network and not USB – the Receiver USB port cannot be used for a direct connection to a computer</li> </ul>
If you cannot connect to a wired network	<ul style="list-style-type: none"> <li><input type="checkbox"/> The Ethernet cable you are using is correctly connected between the receiver and the network hardware.</li> <li><input type="checkbox"/> The network is set up for fixed ip addressing and you have the Receiver set to use DHCP.</li> <li><input type="checkbox"/> The network is set up for DHCP and you have the receiver set to use fixed IP addressing.</li> </ul>
If you cannot connect to a favourite internet radio station	<ul style="list-style-type: none"> <li><input type="checkbox"/> The station is still broadcasting or is not congested – try again later.</li> </ul>
If the internet radio station sound quality is poor or broken	<ul style="list-style-type: none"> <li><input type="checkbox"/> The radio station has a low bit rate (use the <b>INFO</b> key to find this).</li> <li><input type="checkbox"/> The network is not slow or congested.</li> </ul>

# Specifications

## SDP-55

Stereo line inputs	
Maximum input	4.5V rms
Nominal sensitivity	1V, 2V, 4V (user adjustable)
Input impedance	47k $\Omega$
Signal/noise ratio (A-wtd ref 100W) normal/stereo direct	100dB/110dB
Frequency response	20Hz—20kHz $\pm$ 0.1dB
Preamplifier outputs	
Nominal output level (single-ended/balanced)	1V RMS/2V RMS (max. 5V RMS/10 V RMS)
Output impedance	560 $\Omega$
THD+N (20Hz—20kHz)	-100dB
Headphone output	
Maximum output level into 32 $\Omega$	5Vrms
Output impedance	<100 $\Omega$
General	
Mains voltage	110–120V or 220–240V, 50–60Hz
Power consumption (maximum)	50W (Thermal dissipation approx. 170 BTU/hour)
Power consumption (idle, typical)	40W (Thermal dissipation approx. 170 BTU/hour)
Power consumption (standby)	<0.5W
Dimensions W x D (including speaker terminals) x H (including feet)	433 x 425 x 171mm
Weight (net)	10.6kg
Weight (packed)	13.9kg
Supplied accessories	AC cord Remote control with 2 x AAA batteries Manual DAB/FM antenna 3 x WiFi/Bluetooth antennas Calibration microphone USB cable
E&OE	
<b>NOTE:</b> All specification values are typical unless otherwise stated.	

**Continual improvement policy: JBL Synthesis has a policy of continual improvement for its products. This means that designs and specifications are subject to change without notice.**

## SDP-35

Continuous power output, per channel, 8 $\Omega$ /4 $\Omega$	
2 channels driven, 20Hz - 20kHz, <0.02% THD	120W/200W
2 channels driven, 1kHz, 0.2% THD	140W/220W
7 channels driven, 1kHz, 0.2% THD	100W/180W
Residual noise & hum (A-wtd)	<0.15mV
Stereo line inputs	
Maximum input	4.5V rms
Nominal sensitivity	1V, 2V, 4V (user adjustable)
Input impedance	47k $\Omega$
Signal/noise ratio (A-wtd ref 100W) normal/stereo direct	100dB/110dB
Frequency response	20Hz—20kHz $\pm$ 0.1dB
Preamplifier outputs	
Nominal output level	1V RMS (max. 5V RMS)
Output impedance	560 $\Omega$
THD+N (20Hz—20kHz)	-100dB
Headphone output	
Maximum output level into 32 $\Omega$	5Vrms
Output impedance	<100 $\Omega$
General	
Mains voltage	110–120V or 220–240V, 50–60Hz
Power consumption (maximum)	1.5kW (Thermal dissipation approx. 5200 BTU/hour)
Power consumption (idle, typical)	100W (Thermal dissipation approx. 340 BTU/hour)
Power consumption (standby)	<0.5W
Dimensions W x D (including speaker terminals) x H (including feet)	433 x 425 x 171mm
Weight (net)	18.1kg
Weight (packed)	21.4kg
Supplied accessories	AC cord Remote control with 2 x AAA batteries Manual DAB/FM antenna 3 x WiFi/Bluetooth antennas Calibration microphone USB cable
E&OE	
<b>NOTE:</b> All specification values are typical unless otherwise stated.	



## Worldwide Guarantee

This entitles you to have the unit repaired free of charge, during the first five years after purchase, provided that it was originally purchased from a Certified JBL Synthesis dealer. The JBL Synthesis dealer is responsible for all after-sales service. The manufacturer can take no responsibility for defects arising from accident, misuse, abuse, wear and tear, neglect or through unauthorized adjustment and/or repair, neither can they accept responsibility for damage or loss occurring during transit to or from the person claiming under the guarantee.

### The warranty covers:

Parts (excluding disc drives) and labor costs for five years from the purchase date (see below for additional terms and conditions). After five years you must pay for both parts and labour costs.

*Disc drives (of any type) are covered under this warranty for two years from the purchase date.*

*The warranty does not cover battery replacement at any time.*

*The warranty does not cover transportation costs at any time.*

## Claims under guarantee

This equipment should be packed in the original packing and returned to the dealer from whom it was purchased. It should be sent with shipping costs prepaid by a reputable carrier – **not by the post office**. No responsibility can be accepted for the unit while in transit to the dealer or distributor and customers are therefore advised to insure the unit against loss or damage while in transit.

For further details contact JBL Synthesis at [csupport@harman.com](mailto:csupport@harman.com).

## Problems?

If your JBL Synthesis dealer is unable to answer any query regarding this or any other JBL Synthesis product please contact JBL Synthesis Customer Support at the above address and we will do our best to help you.

## On-line registration

You can register your product on-line at [www.jblsynthesis.com](http://www.jblsynthesis.com).



# device code tables

## Amplifier

Adc	007
Adcom	082 092 225 161 269 356
Aiwa	170 018 104 202 203 213 211 188
Akai	189
Amc	125 126 127 281 282
Angstrom	142
Anthem	335 337
Arcam*	001 002 141 418
Atlantic Technology	342
Audio File	071
Audio Matrix	167
Audio Technica	134
B & K	096 097
Bose	070 170 224 347 409 460 903 906
Boston Acoustics	447
Brix	555
Bryston	023
Cambridge Audio	522 523 525 630 683 684 552
Carver	006 028 061 071 201 214 226 185 022 077 284
Cinema Sound	134
Citation	148 272
Clarion	026
Classe	537 410 411
Delphi	515
Denon	109 215 230 234 330 801
Dvico	802
Elan	057 290
Enlightened Audio	099 098
Escient	368 451
Fisher	047 214 182 297
Flextronics	378
Fosgate Audionics	231 342
GE	056
Goldstar	008
Harman Kardon	231 233 153 154 118 318
Hitachi	020
Integra	275 781
Jamo	398
Jcpenney	216
Jensen	058
JVC	163 191 114 279 291
Kenwood	026 066 145 192 182 005 280 374
Kilh	331
Klipsch	042 043 081 687
Koss	216
Krell	072 376 384
Kyocera	007
Lexicon	120 235 236 237 357 360
Linn	124 377
Loewe	904 905 907 908 909

Luxman	139 052 165 115 004 009
LXI	056
Magnavox	086 164 152 208
Marantz	006 028 031 040 063 185 479 251 265 119 289
Mcintosh	238 286
Meridian	100 012 013
Mitsubish	242 243 204
Mondial	157 158 042 043 081 112
Musical Fidelity	647 648
Myryad	276 293
Nad	113 283 478 479
Naim	533 534 535
Nakamichi	040 244 245 172 183 287
NEC	176
Niles	403
Onkyo	017 046 108 080 209 275
Optimus	026
Outlaw	342
Panasonic	032 195 219 177 292 383
Parasound	129 130 132 261 294 295 333 334
Philips	249 250 251 063 119 805
Pioneer	014 044 069 168 116 035 078 198 480
Polkaudio	515
Primare	461 462 463 464 465
Proceed	144 268
RCA	010 048 117 156 067 288
Realistic	019 056 073 075 095
Rotel	074 083 085
Russound	379 391 392
Samsung	016 804
Sansui	040 048 110 119 065 228
Sanyo	047
Scott	019 091
Sharp	026 094 026 175
Sherwood	024 102 106 447
Sirius	555
Sony	018 247 248 166 101 184 218 271 369 372 380
SSI	068
Sugden	430
Sunfire	344 345 346
Systemline	759
Teac	005 019 049 040 212 217
Technics	122 176 193 219 178 177 200 257 262

## CD

Adcom	062 042
Aiwa	089 170 187
Akai	202
Amc	231 232
Arcam	001 238 275
Audio Access	119 147
Audio Ease	165
Audio Technica	046
California Audio	147 008
Cambridge Audio	268
Carver	185 041 050 067 107 130 134 135 138 139 203 167
Classe	267
Creek	159
Denon	002 123
Emerson	042
Fisher	050 185 134 008
Genexxa	010
Goldstar	080
Harman Kardon	033 047 208
Hitachi	042 175
Inkel	130
Insignia	298
Integra	030 273
Jcpenney	141
Jensen	158
JVC	004 022 136 163 213 214 242 243
Kenwood	185 007 023 055 071 072 142 137 254
Krell	241 255
Kyocera	005
Linn	295
Loewe	256
Luxman	011 028 070 249 252
Magnavox	107
Marantz	041 051 077 107 209 246
Mcintosh	212 247
Memorex	010
Mission	107
Mitsubishi	179
Mondial	147
Musical Fidelity	258 284
Myryad	244 155
Nad	006 005 067 178 293
Nakamichi	217 218
NEC	062
Nikko	046
Nsm	107

Onkyo	030 038 039 168 169
Optimus	010 050 081
Panasonic	147 172 008 068 248
Parasound	233 240
Philips	041 107 246
Pioneer	010 020 174 175 176
Primare	266
Proceed	239
Proton	107
Quasar	147 008
RCA	017 042 150
Realistic	042 050 051 187
Rotel	107 161 178 250
SAE	107
Sansui	107 128 171 190 125
Sanyo	050
Sharp	026 031 051
Sherwood	051 096 112 115 119 166
Signature	033
Sony	048 081 097 126 133 177 226 164
Soundesign	251
Sumo	155
Sylvania	107
Symphonic	052
Tandy	010
Teac	051 052 233 079
Technics	147 172 184 008 068
Theta Digital	234 235
Toshiba	006 067 091 160 148
Victor	004 022
Wards	185 033
Yamaha	024 046 054 186 183 245

Note - for JBL Synthesis amps:

001 = RC5 code 16

002 = RC5 code19

## DVD

Aiwa	146
Akai	281
Alpine	098
Apex Digital	087 282 115
Arcam	001
Broksonic	130
Cambridge Audio	215 323 333
Cinevision	091
Coby	260
Cyberhome	271
Denon	138 080 173 358
Durabrand	091
DVD 2000	017
Emerson	091 143
ESA	143
Fisher	147
Funai	143
GE	027
Go Video	137 091 220 221
Goldstar	091
Harman Kardon	084 140
Hitachi	101
Initial	282
Insignia	143
Integra	142 338
JBC	084
JVC	012
Kenwood	151
Kiss	279
KLH	135
Krell	104
Lexicon	148
LG	091 057
Linn	306 309
Liteon	264
Loewe	359 360
Magnavox	001 096 143 282
Marantz	083 095
Meridian	153
Microsoft	027
Mintek	282
Mitsubishi	017
Myryad	102 134
Nad	088 353
Nakamichi	103
Onkyo	076 141 142 338
Oppo	341
Optimus	107
Orion	130
Panasonic	042 138 144 150 285
Philips	083 095 166 344
Philips-Magnavox	141 001
Pioneer	023 092 099 107 108 131 304 354
Polaroid	233
Polkaudio	141 001
Primare	193 194
Proscan	027
RCA	027
Rotel	335 336
Samsung	056 165 170 137 159 275

Sansui	130
Sanyo	147
Sears	130
Sharp	094
Sherwood	245 246 247 248 249 250 345
Sony	033 118 145 126 191 286 242 243 343 340
Superscan	143
Sv2000	143
Sylvania	143
Symphonic	143
Tag McLaren	156
Tatung	102
Teac	107
Technics	042
Techwood	088
Thompson	027
Toshiba	130 141 164 188 273 356
Venturer	149
X-Box	027
Yamaha	042 089 166 138 197 334
Zenith	057 091

## DVD-TV combo

Aiwa	146
Akai	281
Durabrand	143
Esa	143
Funai	143
Insignia	143
Magnavox	282
Mintek	282
Samsung	165
SV2000	143
Sylvania	143
Symphonic	143
Toshiba	130

## DVD-TV-VCR combo

Emerson	143
Insignia	143
Magnavox	143
Panasonic	144
Superscan	143
Sylvania	143
Toshiba	164

## DVD-VCR combo

Go Video	137
Panasonic	150
Philips	001 (VCR functions 067)
Samsung	137 159
Sansui	130

Sony	145 191
Toshiba	141
Zenith	091 (VCR functions 101)

## DVD-Recorder

Cyberhome	271
Go Video	220 221
Kiss	279
Panasonic	138
Samsung	301
Sony	191
Toshiba	188

## Blu-ray/HD-DVD

Denon	358
LG	091
Nad	353
Onkyo	338
Panasonic	285
Pioneer	304 354
Samsung	275
Sony	286
Toshiba	273 356
Yamaha	197

## Satellite STB

Acoustic Solutions	002 060
Akura	002 020 026 099 100
Alba	002 016 020 023 027 032 044 058 061 070 118
Antiference	073
Argos	044
Asda	002 099
Astratec	011
Astro	024
Audioline	007
Aurex	002
Black Diamond	002
Boca	024
Bush	002 007 009 011 016 020 023 027 029 030 032 044 052 053 058 062 064 069 073 079 092 098 102 103 112
Comag	024
Crown	002
Currys	062
Curtis	062 099
CYRUS	129
Daewoo	011 109
Digifusion	009 011
Digihome	002 020 073
Digilogic	002 026

Digitalstream	093
Dion	066 089 120
Dreamax	119
Dual	020
Durabrand	002 020 055
Essentials	062
Evesham	020
EZ Box	101
Ferguson	001 012 013 020 026 062 072 073

Fetch TV	086
Finlux	073 100
Freecom	045
Fuba	017
Fusion	009 011
Globo	024
Goodmans	002 011 019 020 023 027 029 030 032 044 058 064 069 070 071 098 102 103
Grundig	001 002 003 004 027 030 044 058 059 064 069 070 074 075 084 098

Hirschmann	024
Hitachi	002 020 082
Humax	012 018 028 035 048 049 050 051 054 108 115 116 117

i-Can	094
Icecrypt	063 090 095
Inverto	021
Kabel Digital	042 057
Kabel Figital	048
Labgear	026 104
Linsar	002 020 065 073 079
Lodas	002
Logik	002 013 020 036 062 065 087 092

Logisat	024
Lowry	073 085
Luxor	020 073 079
Manhattan	070 076
Asda	020
Matsui	002 011 061
Medion	024
Meo	031 081
Metronic	007 046 047 067 068 072 073 076 077 079

Mico	016
Morgans.S.L.	024
Murphy	100
Nichimen	023
Nikkai	085
Onn	002 020
Pace	057 078 125
Pacific	002
Palcom	017
Panasonic	006
Philex	062
Philips	007 014 031 033 034 080 114
Premiere	048 054 057 116

Proline	002 016 020 026 062
Sagecom	056 096
Sagem	008 015 056 105
Samsung	037 038 091 111
Scientific Atlanta	081
SEG	002
Setanta	007
Sharp	020 079 083 088
Sky	048 054 125

Sky-digital	127
Sky HD	130
Sky+	128
Skymaster	017
Sony	010 110
Strong	002
TDC	081
Technika	002 020 058 070 073 086 087
Technomate	039 040 041 126
Technosonic	007
Techwood	002 020 079 100
Telewest	025
Tevion	007 017 023 104
Thomson	003 005 042 043 079 113

Top Up.TV	007
Topfield	090
Toshiba	002
Triax	024 083 088
TVOnics	013 036 121 122 123 124

TWF Digital	007
Virgin Media	013 025
Walker	020
Wharfedale	002 020 079
Winix	097
Xenius	073
Yamada	026
Zon	078

## Satellite Radio

Brix	555
Delphi	515
Polkaudio	515
Sirius	555
Sony	380
XM Satellite Radio	515

## TV

A.R.Systems	160 418
Adl	299
Admiral	058 137 204 245 246
Adyson	159 219
Aeg	031 109 123 249 263 282 286 319 407
Ag	282
Ahb Isions	131
Aiostay	144

Akai	027 036 074 097 103 104 106 108 132 140 155 156 242 243 249 250 251 275 279 280 287 407 409 410
------	---

Akita	085
Akura	064 074 086 108 171 174 407 410 429 430 431

Alba	060 064 069 074 108 127 172 175 202 249 250 264 307 407 409
------	---

Alien	264
Allstar	108 251
Altus	250
Amstrad	025 074 123 171 245 249 286 407 409

Anam	285
Andersson	123
Anitech	108 185 219 251 267 277 410

Ansonic	108
Antecno	064
Aoc	016
Arc En Ciel	173 179
Arcelik	085 086 296
Ardem	085 250
Arena	127 250
Argos	250
Aristona	109 111 119 122 230

Asa	087 102 105 234
Asberg	185 267
Asora	171 410
Astrosound	108
Asuka	149
Atlantic	089 197
Audiosonic	074 085 090 108 110 159 164 171 185 218 250 263 267 269

Aurora	170 171 219
Autovox	123 158 159 163 197 249 282

Awa	108
Awatron	171
Axxion	409
Baird	032 188
Bang & Olufsen	204 239
Basic Line	033 108 120 170 249 264 277

Baur	036 042 045 074 092 096 097 108 111 131 132 134 158 171 211 212 216 217 233 251 256 266 408 414
------	---

Baysonic	410
Beko	049 085 086 090 108 117 130 195 225 250 255 263 296

Belstar	108 116 249
Best	282

Bestar	086 108 249
Black Diamond	120 249
Black Panther	185

Blaupunkt	091 092 096 097 099 119 253 256
Blue Sky	109 172 249 250 264 273 282 286 407

Bluestar	063 108
Bomann	282
Bondstec	163
Boxford	418

Brandt	173 179 193 195 270
--------	---------------------

Brionvega	204 245
Broksonic	285
Brother	410
Brunns	204

Bsr	144 247
Bush	031 063 069 074 108 115 121 123 136 144 202 243 249 250 264 283 286 287 303 314 407 409

Camper	085
Cello	301 310 311 312 315 318

Century	165 204
Cge	165 243 260 267
Cgm	085 086 108 264
Cie	025 064 108 166 170 171

Cineral	272
Cinex	031 294 407
Clarivox	161 232 258

Clatronic	064 074 108 110 144 149 159 164 165 171 185 218 249 250 255 260 267 282 286 294 296 407 409 410
-----------	---

Condor	108 109 149 171 229 255 260 267 418
--------	-------------------------------------

Conic	219
Conrac	225
Contec	171 277
Conti	250 263
Continental	172

Continental Edison	172 173 179 193
Cosmos	108
Crosley	148 165 204 267
Crown	063 085 086 090 108 144 171 185 249 250 255 263 264 267 274 282 286 407 409 418

Cs-Electronics	064 159 163
Curtis	111 260
D-Vision	108 407

Daewoo	108 120 127 170 269 432
--------	-------------------------

Dansai	219 410
Dantax	074 250
Daytek	194
De Graaf	134

Decca	063 066 069 108 128 159 161 184 189 407
-------	---

Delton	249
Denver	074 171 282 408
Desmet	108

Dgm	427
Digifusion	225
Diginum	031
Digix	187
Disney	062
Dmtech	249 286 304 308 320
Dmtechnot Included	322
Domus	108
Dual	108 123 127 158 233 243 248 249 250 279 286 293
Dumont	087 102 105 109 110 185 204 234 267
Durabrand	249 282
E-Max	194
Ecg	069 117 250
Edison	172
Edison Minerva	172
Elbe	058 074 108 120 144 160 185 209 229 245 246 273 407
Elbit	108 248
Elicit	164
Electric	109
Electric Co	250
Elekta	108 144 159 171 410
Elektronika	086 108 116 274
Elemis	031 074 282 294 407
Elin	087 108 132
Elite	064 149 410
Elman	144 185
Elta	108 171 410
Emerson	086 108 204 409
Esc	108
Etron	242
Euroline	286
Europhon	033 144 159 160 161 185
Eurosky	249 407
Evelux	108 116
Expert (I	089
Exquisit	108 110
Fenner	108 171 249 251
Ferguson	032 078 160 162 195 198 199 200 201 270
Fidelis	108
Finlandia	033 104 105 189 195
Finlux	031 066 069 074 087 102 103 104 105 107 108 116 128 140 144 156 159 161 189 225 229 234 251 275 276 279 290 407
First-Line	108 144 158 246 249 251 264 273 294
Fisher	051 052 086 158 159 221 233
Flint	273
Force	123 194 286

Formenti	108 109 110 149 159 229 407
Fraba	108 248
Frontech	136 159 166 171 220
Fujitsu General	088 159 197 247
Funai	249 264 286 293 410
Galaxis	108 185 255 260
Galaxy	255
Galeria	171
Gbc	137 144 148 161 171 198 267 269
Gec	129 147 159 189 411
Geloso	064 137 144 148 164 171
General	171
General Technic	171
Gericom	187 225 300
Goldfunk	249 264
Goldhand	159 171
Goldline	273
Goldstar	038 074 090 108 110 136 144 159 163 166 171 191 219 237 247 250 263 268 288 410
Gooding	172
Goodmans	031 063 064 068 074 103 108 109 110 115 120 123 159 170 171 176 187 194 195 224 225 249 250 251 264 268 269 270 275 285 286 287 305 306 316 321 407 409
Gorenje	086 090 108 116 249 274 286
Gpm	064 410
Gradiente	038
Graetz	108 132 134 141 145 147 148 156 172 242 244 249 250 263 296 414 418
Gran Prix	031 127 294 407
Granada	022 027 029 032 033 036 039 041 042 043 045 049 051 054 075 078 079 081 082 085 086 090 103 104 105 108 109 111 119 128 134 135 140 145 156 159 167 184 189 195 208 218 224 251 270 403 414
Grandin	069 273
GreatWall	074 408
Grundig	031 063 069 073 091 092 094 096 097 100 101 116 117 130 155 172 187 194 202 210 232 250 253 287 407
Gxk	407
H&E	282
Haier	313

Hanseatic	060 085 100 108 110 120 127 132 136 144 149 158 171 191 220 225 229 248 250 251 269 277 296 308 402 407 414
Hantarex	161
Hantor	159
Harwa	297
Hb	282
Hb Ingelen	172
Hcm	108 159 171 277 410
Hifivox	173 179
Hinari	064 108 171 224 242 410
Hisawa	273
Hisense	302
Hit	204
Hitachi	022 023 024 028 029 030 035 039 040 041 053 054 055 056 057 104 108 119 120 123 127 128 129 134 135 140 145 147 156 159 161 173 186 189 193 219 249 266 269 276 279 286 295 411 413 415 417 421 423
Hitsu	273
Hi	108 195 251
Hoher	069 117 123 249 250
Hoshai	264
Hyper	159 163 171 409
Hypson	063 069 074 108 118 162 249 250 263 264 293 407
Hyundai	152 155 180 235 317
Ibervisao	144
Ice	064 108 159 171 409 410
Ideal	264 407
Imperial	108 109 110 144 154 165 229 243 255 260 267 407
Ingelen	132 141 147 148 242 244 273 279
Ingersoll	171
Inno Hit	127 159 161 189 237 249
Innovation	410
Intercord	233
Interfunk	067 108 132 134 137 141 147 148 165 179 242 244 251 255 265 414
Intervision	085 086 108 132 144 166 191 410
Ipostar	171
lrc81177	324
lrc81456metz	323
Irradio	074 108 163 237 249 264 408
Iskra	085
lrc	144 159
Itl	171

Its	064 159 171 409 410
Itt	031 032 117 132 134 140 141 144 145 147 148 156 158 242 244 250 268 414 418
Jetpoint	268
Jmb	063
Jocel	069 074 282 283 408
Jvc	120 169 278 409
K Classic	407
Kaido	136
Kaisui	127 249 273 280 410
Kamacrown	064 410
Kapsch	089 141 147 148 197
Karcher	031 074 108 109 117 185 250 273 274 282 289 407 418
Kathrein	187
Kawa	409
Kendo	060 108 127 137 229 245 246 249 270 273 296
Kennedy	148 197
Kennex	108 249 264
Keymat	207 235
Kiton	249 264 293
Kneissel	058 108 229 249 264 273
Koerting	086 204 274
Konka	409
Kotron	410
Kuba Electronic	134 158 233
Lazer	074
Lecson	116
Lenco	108 110 170 249 410
Lenoir	249 264
Level	426
Lg	013 014 015 038 069 090 108 110 181 250 263 283 286 288
Liesenkoetter	108
Lifetec	064 074 108 118 127 170 171 249 264 293 408 410
Loewe	046 093 095 131 138 142 143 151 190 204
Logik	070 187 264
Luma	137 197 229 246 249
Lumatron	229 245 246 249
Luxor	032 066 074 103 104 105 116 128 132 134 140 145 153 156 159 186 237 242 249 251 267 275 276 279
M Electronic	103 104 105 120 127 140 276
M.D.C.	074
Macrolux	069
Magnadyne	108 148 158 161 163 164 185 204

Magnafon	185 199
Magnasonic	108
Magnavox	251
Magnum	031 074 250 263 294 407
Manhattan	249 264
Marantz	108
Marshal	064
Mascom	031 074 279 407
Masters	108
Matsui	025 032 051 060 062 063 069 070 074 096 100 108 116 136 154 159 171 172 196 202 249 250 407 409 416
Maxell	249
Maxim	031 407
Medion	031 074 108 110 127 187 194 225 249 250 251 264 279 283 287 293 407 408
Megas	273
Memorex	410
Memory	286
Merrit	132
Meteor	185
Metz	074 092 096 097 100 101 108 219 249 254 264 265 322 323
Micromaxx	074 249 250 264 282 293
Mikomi	286
Minerva	092 097 100 172 232
Mitsai	110 407
Mitsubishi	071 075 076 077 097 119 120 204 224 249
Mivar	159 161 209 223 259 262 267
Mmc2	001 002 003
Morava	109 152 249 418
Mosaic	249 264
Mt Logic	250
Mtc	086 131 134
Multitec	249 264 407
Multitech	031 085 090 108 136 159 171 185 267
Muryuana	251
Naiko	407
Nakimura	170
Naonis	137
Neckermann	037 043 059 060 074 084 092 096 100 101 108 118 119 134 135 137 159 169 204 211 212 216 217 233 245 250 251 255 256 274 404
Nei	064 108 402
Neufunk	109 249 250
Nexius	282
Nike	108
Nikkai	219
Nikkei	249 264

Nikko	108
Nissan	268
Nobliko	185 232 267
Nogamatic	173 179
Nokia	032 074 102 103 104 105 106 132 140 141 145 156 158 242 244 251 275 276 279 414
Nordmende	069 129 147 173 179 193 195 249 261 270 282 296
Nordway	243
Norm N	108
Nortek	249 264
Nova	087
Novatronic	108
Oceanic	032 103 104 132 140 156 276
Okano	108 255
Onwa	064 108 280 409 410
Opera	250
Orava	090 098 108 150
Orbiter	086
Orion	025 059 060 062 063 064 069 070 074 108 118 158 162 185 187 194 196 202 205 219 236 249 250 251 296 407 409 410
Orion (H	062 074 108 116 228 249 407 410
Ormond	249
Osaki	108
Otake	059 060 144 196
Otava	418
Otf	090 108 204 282
Otto-Versand	026 027 036 040 059 060 063 069 074 081 082 083 084 092 096 097 100 101 108 110 111 116 118 119 127 131 132 134 136 145 149 152 158 159 163 167 168 171 185 193 195 202 205 211 212 213 216 217 230 233 250 251 269 270 277 401 402 404 405 406 409 412
Ovp	090 098 108
Pacific	063 109 236 249 250
Palladium	031 108 118 127 134 137 161 165 171 229 245 249 250 255 260 276 293 407
Panasonic	148 167 168 254 401 402 403 404 405
Pathe Cinema	144
Pathe Marconi	173 179
Philco	108 144 148 154 165 204 243 255 260 267

Philips	007 008 009 019 020 021 065 067 069 092 108 109 111 112 116 119 122 230 251 406 407 412
Phocus	117 130 225 250
Phoenix	090 108 110
Pioneer	108 132 193 407
Pionier	090
Playsonic	090 250
Powerpoint	172
Prandoni	066 069
Prandoni-Prince	137 161
Premier	069

Prima	219
Prime	249
Primus	251
Pro 2	031 407
Profex	136 171 267
Profilo	031 074 108 294 407
Profitronic	108 185
Proline	109 120 128 189 205 229 249 269 270 285 286 407
Prosonic	418
Protech	074 108 219 249 264
Provision	066 108 109 120 282 418
Pye	108 109 251
Quadro	123 249 286 293
Quelle	261 257 255 251 245 237 234 232 229 221 219 218 217 216 213 212 211 205 204 197 195 185 171 169 168 167 165 159 158 156 144 142 141 140 136 131 119 118 116 112 111 108 105 102 101 100 097 096 092 090 088 087 086 074 072 060 059 043 042 040 036 027 025
Radiola	065 067 108 251 420
Radiomarelli	108 161 164
Radionette	181
Radiotone	074 085 108 171 249 294 407 410
Rank/Bush/Murphy	232
Recor	108 249
Rediffusion	132
Redstar	282 407
Reflex	108 249 264 293
Reoc	250
Revox	131
Rex	088 089 137 164 197 245 246 247
Rft	064 085 116 132 204
Rm 2000	108 249 264
Roadstar	063 069 090 108 117 144 249 250 251 263 264 280 286
Robotron	204
Rosita	171
Rowa	249 283
Royal	277 410
Royal Lux	282
Saba	074 147 148 161 173 179 193 195 249 270
Sagem	206 273
Saisho	025 060 069 070 136 159 205
Sakio	171 410

Salora	032 066 074 103 104 105 116 128 132 134 135 137 140 145 156 159 237 242 249 251 275 276 279
Sambers	161 185 267
Samsung	045 086 108 126 159 171 220 237 257 268 284 408 410
Sankyo	108
Sansui	108 249 264 410
Sany	193
Sanyo	032 033 051 052 074 086 087 108 123 159 189 218 221 249 286 407 414 420
Schaub Lorenz	074 108 116 117 132 141 147 148 156 171 242 249 250 264 275 277 296 410
Schneider	063 064 069 088 108 116 127 141 152 158 159 163 233 242 243 249 250 251 264 269 282 324 409
Schneider (F)	065 067 251
Seelver	069
Seg	064 108 115 123 144 159 165 171 185 219 249 264 267 269 286 293 410
Seitech	282 407
Seleco	088 089 109 110 137 195 197 226 229 245 246 247 249 251 407
Select	264
Sencor	117
Sentra	049 064 242
Serino	273
Set	074
Sharp	073 081 082 083 084 171 224 424 433
Shintom	108 249
Shintoshii	108
Shivaki	108 144 249 264
Siarem	148 161 185 204
Siemens	074 092 096 097 100 101 218 219 221 256 294
Siera	069
Silva	243 407
Silva Schneider	031 074 282 286 294 407
Silver	064 074 171 224 277 410
Sim2	226
Singer	069 108 164 185 204 251
Sinudyne	025 062 063 069 074 118 148 158 162 185 196 204 212 249 251 282 407
Sky	187 194 207
Six	264 407
Smaragd	172

Smc	418
Solavox	242
Sonitron	159 407
Sonix	194
Sonoko	249
Sonolor	140 156
Sontec	108
Sony	072 211 212 213 214 215 216 217
Soundcolor	074 108 249 264 407
Spectra	170
Standard	108
Starlite	108 171 264
Starlux	171
Stars	251
Stern	088 089 137 197 229 245 246 247
Strato	410
Strong	115 123 286
Sunkai	273
Sunstar	074 108 171
Superior	286
Supertech	074 108 171 243 249
Suprema	273
Swisstec	187 194 207 309
Tadistar	108
Tandberg	173 246 254
Tashiko	159 218 224
Tatung	063 066 069 070 079 108 118 128 159 161 184 189 282 286 407
Taurus	282 418
Tcl	152
Tcm	127
Td Design	131 140
Tec	108 144 159 165 166 170 171 243 247 249 264
Techline	108 123 185 249 264 293
Technica	249 282 286 407
Technisat	108 118 248
Techwood	115 123 249
Tecnimagen	069 251 407
Tecnison	108 159 171 249
Tecsonic	249
Tekon	171 268
Teleavia	173 178 179
Telefunken	177 179 193 195 225 261 270
Teleopta	171
Telerent	131 233
Telestar	031 074 108 227 282 294 407
Teletech	108 165 171 249 264
Teleton	088 089 134 159 197 247
Televiuew	031 407
Telra	031 074 108 294 407
Tensai	064 108 110 120 127 144 149 159 171 191 249 264
Tenson	171

Tesla	069 074 090 108 109 116 127 144 150 160 204 229 249 250 263 264 273 282 407
Tevion	127 225 249 250 264 287 294 407 408
Tewa	409
Thomson	134 173 179 193 195 261 270
Thomson Ir2000	004 005 006
Thomson Rec 80	010 011 012
Thorn	026 028 032 033 036 043 045 049 052 065 067 072 075 078 079 087 097 102 105 106 107 108 110 116 120 128 132 135 141 145 156 159 160 161 168 169 170 177 179 188 189 195 198 199 200 201 211 213 216 224 232 242 244 251 270 411 414 415 416
Thorn-Ferguson	160 188 195 198 200
Tobo	171 410
Tokyo	268
Topline	249 264
Topvision	085
Toshiba	026 027 036 037 042 043 045 047 048 049 050 063 092 100 202 203 208 232 249 250 268 284 416
Tosumi	250
Towada	144 185
Trans-Continents	069
Trilux	120 264 292
Tristar	064 410
Triumph	025 219 234
TVE	249
TWF	320
Uher	089 108 131 149 185 197 233 249
Ultravox	108 148 164 185 204
Unimor	085 086
United	063 090 108 170 250 263 282 286
Universum	025 074 086 087 097 100 102 103 104 105 108 109 116 123 140 171 218 219 227 229 234 237 243 245 249 260 264 270 274 275 276 279 286 293
Univox	204
Vestel	108 115 121 123 243 249 264 286 293 303
Vestl	434
Videocom	425
Videocon	410
Videosat	165
Vidoseven	187 194

Videoton	144 145 178 193 249 410
Vision	108 149 249
Visionmagic	187
Vog	069
Voxson	137 204
Walker	286
Waltham	134 145 159 171 178
Watson	064 074 108 127 149 171 194 249 264 293 410
Watt Radio	148 158 185
Wegavox	243 249 264 282 408
Weilltech	250
Weltblick	108 110
Weston	413
Wharfedale	313 418
White Westinghouse	108 110 149 260
Wiewpia	428
Wilson	249
Winson	250
Worten	110 120 229 273 407
Xenius	298
Xiron	303
Yamo	064
Yoko	064 108 136 144 159 164 170 171 274 410
Zanela	224
Zanussi	137 197





Harman International Industries, Incorporated  
8500 Balboa Boulevard  
Northridge, CA 91329 USA